

TANDEM diagonal junior

300 mm

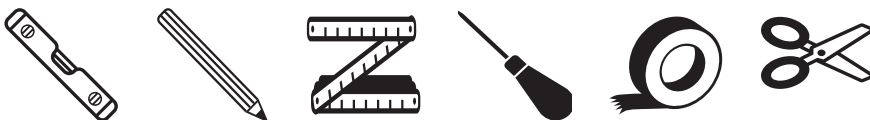

<https://support.kesseboehmer.de>

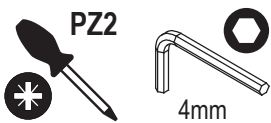
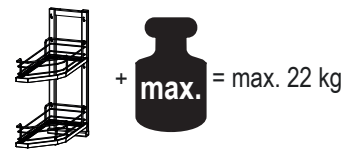
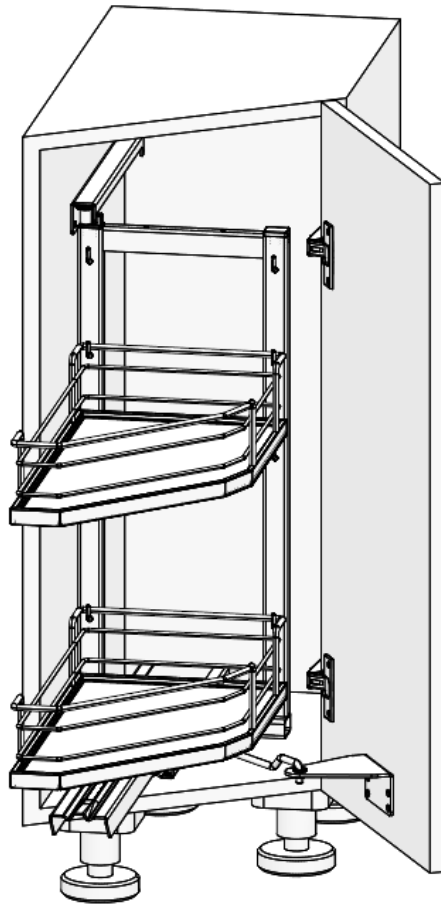

TANDEM diagonal junior

300 mm

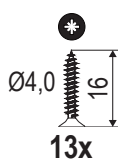
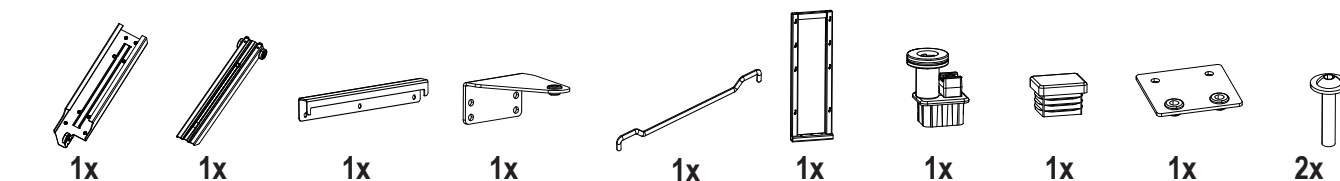
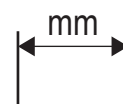

DE Die technischen Darstellungen und Maßangaben – auch bei Abbildungen und Zeichnungen – sind unverbindlich. Konstruktions-verbesserungen sind vorbehalten! **UK** Technical information and stated dimensions (including in illustrations and drawings) must not be regarded as binding. Design subject to change without notice (in interest of improvement)! **FR** Les illustrations techniques et les cotes – y compris sur les schémas et les dessins – sont non contractuelles. Sous réserve d'améliorations de la construction ! **IT** Le rappresentazioni tecniche e le indicazioni delle dimensioni – anche nelle figure e nei disegni – non sono vincolanti. Con riserva di miglioramenti di progettazione! **ES** Las descripciones técnicas y los datos dimensionales, inclusive los incluidos en fotos y figuras, son meramente orientativos y no vinculantes. ¡Reservado el derecho a mejoras constructivas! **PT** As descrições técnicas e as indicações de medidas – também em ilustrações e desenhos – não são de natureza imperativa. Salvo melhoramentos de construção! **FI** Tekniset piirroksset ja mitat – myös kuvissa ja piirroksissa olevat – ovat sitoumuksetta. Oikeus teknisiin parannuksiin pidätetään! **DK** De tekniske fremstillinger og måleangivelser – også i figurer og tegninger – er vejledende. Forbehold for konstruktionsforbedringer! **CZ** Technické znázornění a rozměry – i na obráz-cích a výkresech – jsou nezávazné. Konstrukční změny vyhrazeny! **PL** Prezentacje techniczne i dane wymiarowe – także na rysunkach – są nie-wiążące. Zmiany konstrukcyjne zastrzeżone! **RU** Иллюстрации технических деталей и указанные размеры, в том числе на рисунках и чертежах, являются ориентировочными. В конструкции возможны изменения! **TR** Teknik resimler ve ebat bilgileri –fotokopi ve çizimler dahil –bağlayıcı değil-dir. Konstrüksiyon düzeltmeleri saklı tutulmaktadır! **GR** Οι τεχνικές απεικονίσεις και οι διαστάσεις – ακόμα και αυτές που εμφανίζονται στα σχέδια – δεν θεωρούνται δεσμευτικές. Διατηρούμε την επιφύλαξη κατασκευαστικών βελτιώσεων! **JP** 技術データおよび寸法は、改良などによって変更されることがあります。 **CN** 技术图纸和数据 (即使在插图和图纸中) 均不具备法律效力。公司保留进行设计更改的权利!

TANDEM diagonal junior

300 mm



i

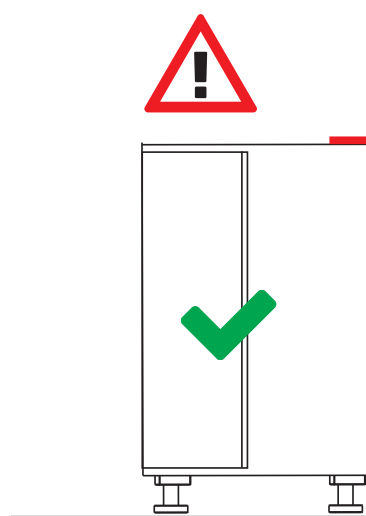
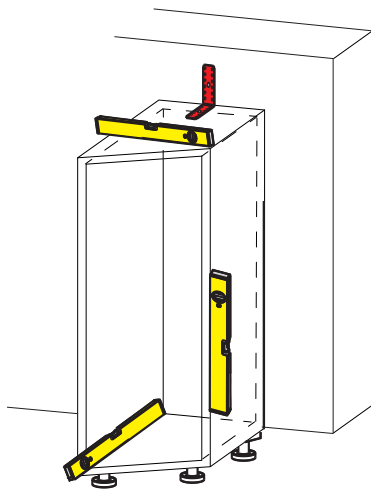

i

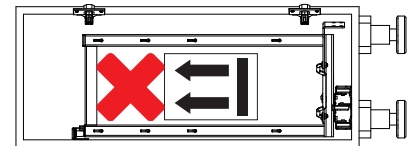
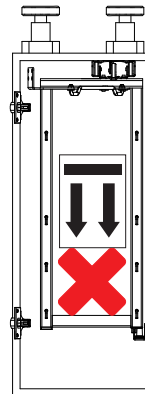
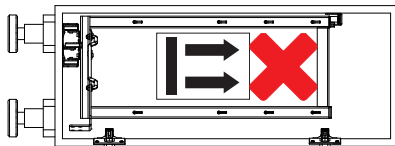
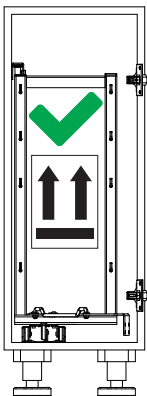

i

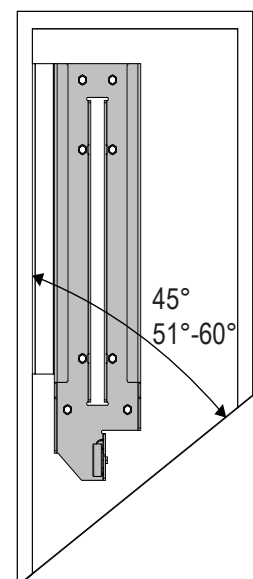
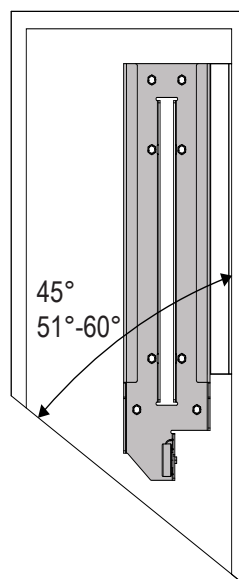
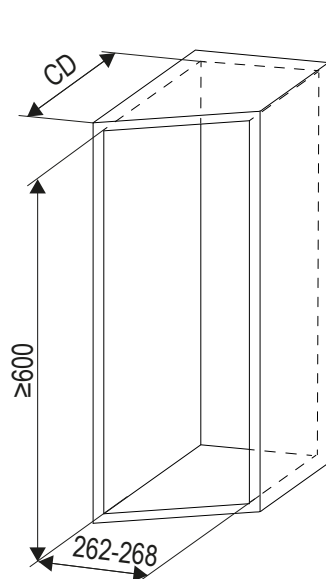

TANDEM diagonal junior

300 mm



1



1x

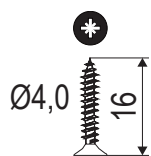

6x



PZ2

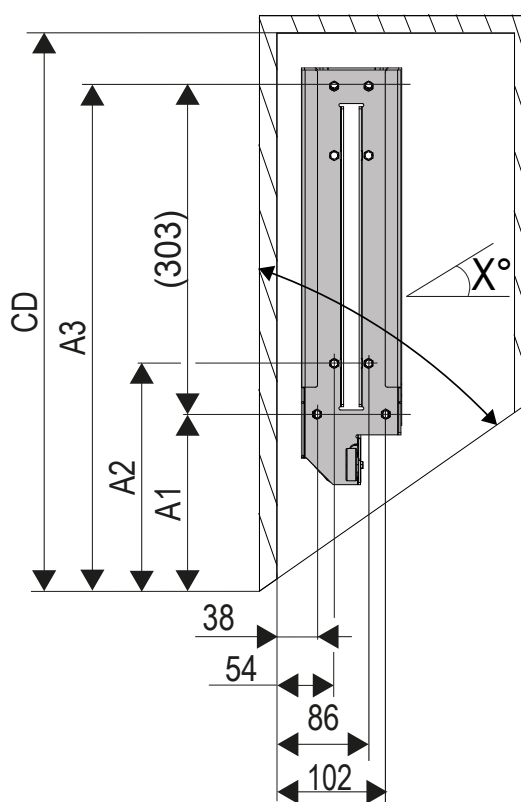
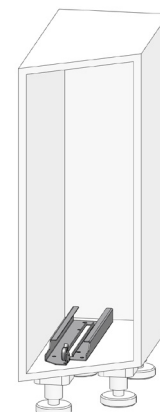
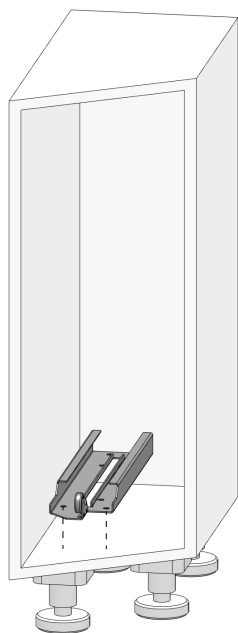

$\angle X^\circ$	A1	A2	A3	CD
45°	205	252	508	530
51°	175	222	478	500
52°	173	220	476	498
53°	171	218	474	496
54°	169	216	472	494
55°	167	214	470	492
56°	165	212	468	490
57°	163	210	466	488
58°	161	208	464	486
59°	159	206	462	484
60°	157	204	460	482

TANDEM diagonal junior

300 mm



2

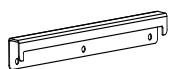

1x

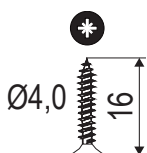

3x

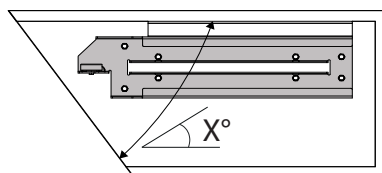
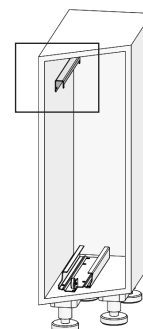
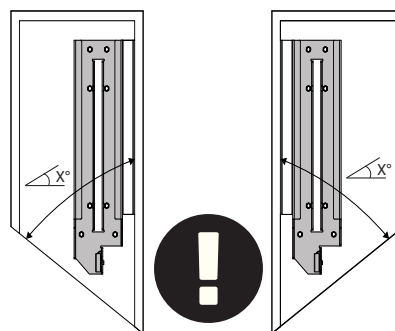
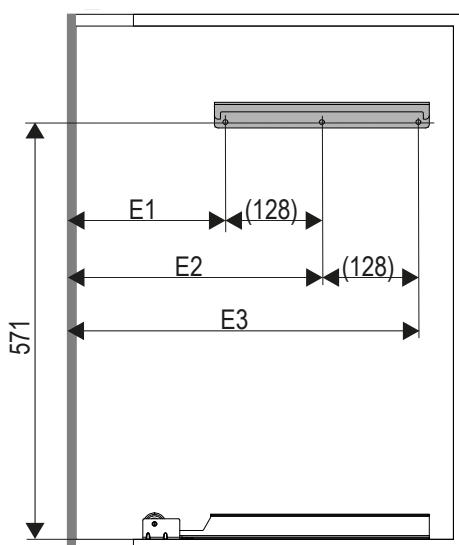

X°	E1	E2	E3
45°	257	385	513
51°	227	355	483
52°	225	353	481
53°	223	351	479
54°	221	349	477
55°	219	347	475
56°	217	345	473
57°	215	343	471
58°	213	341	469
59°	211	339	467
60°	209	337	465

3

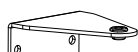

1x

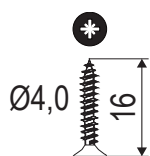

4x

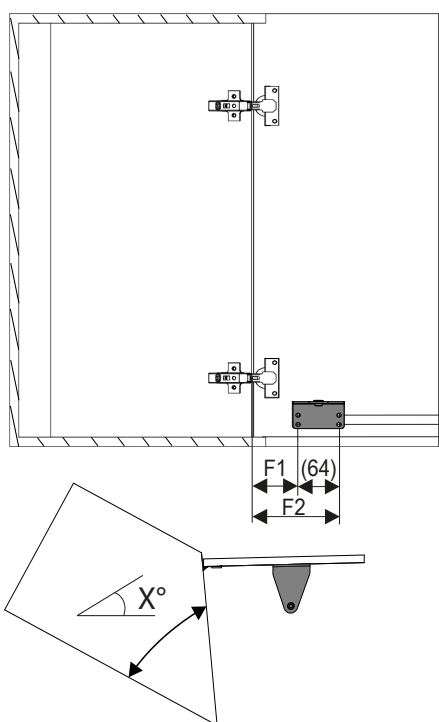

X°	F1	F2
45°	172	236
51°	170	234
52°	167	231
53°	164	228
54°	161	225
55°	158	222
56°	155	219
57°	152	216
58°	149	213
59°	146	210
60°	143	207

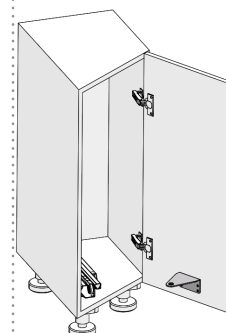

TANDEM diagonal junior

300 mm



4

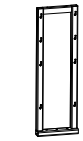

1x



1x



1x

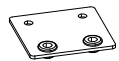

1x



2x



1x

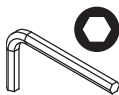

4mm

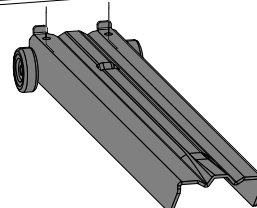
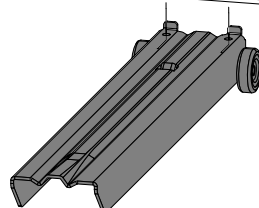
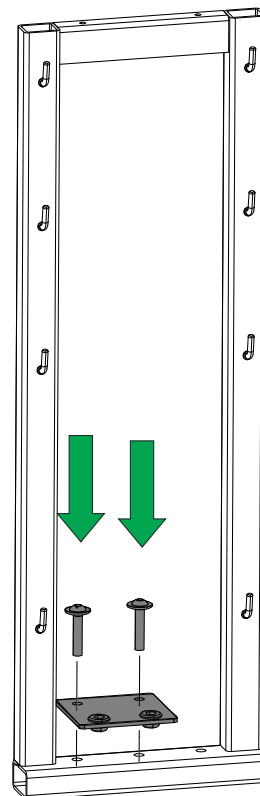
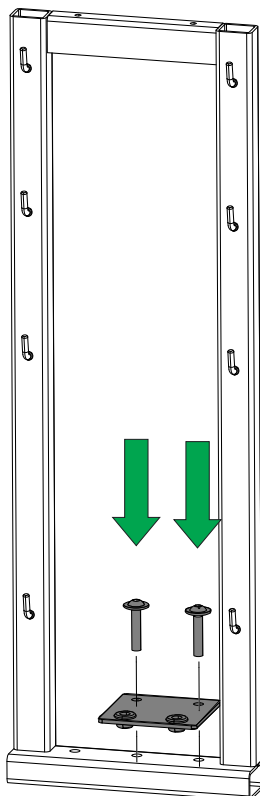
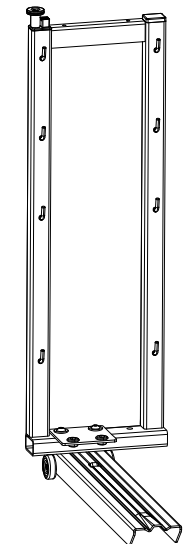
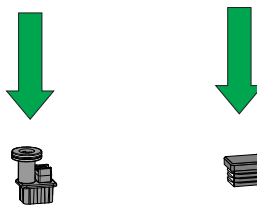
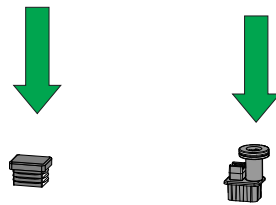
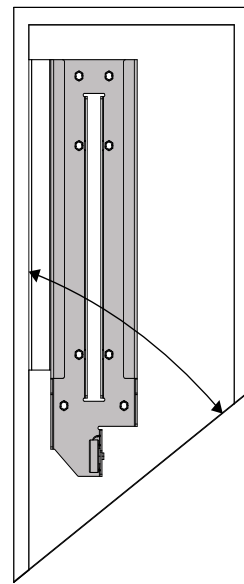
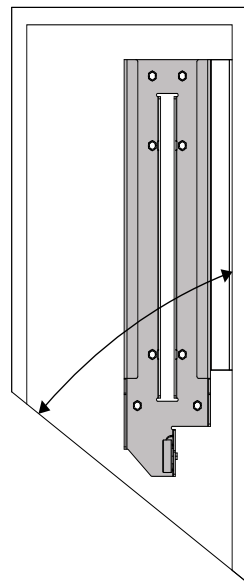

TANDEM diagonal junior

300 mm



5

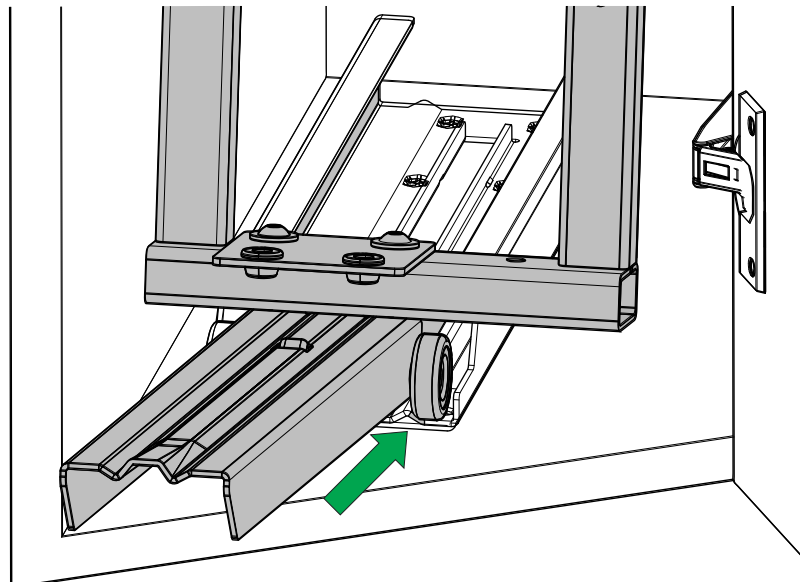
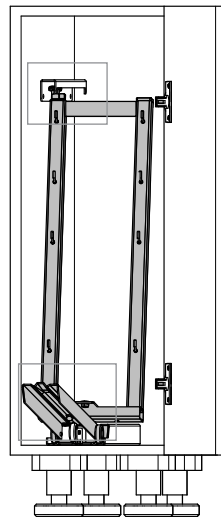
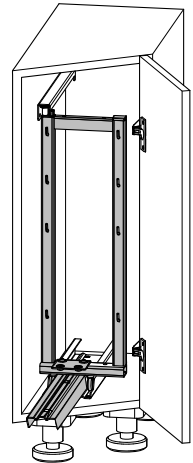
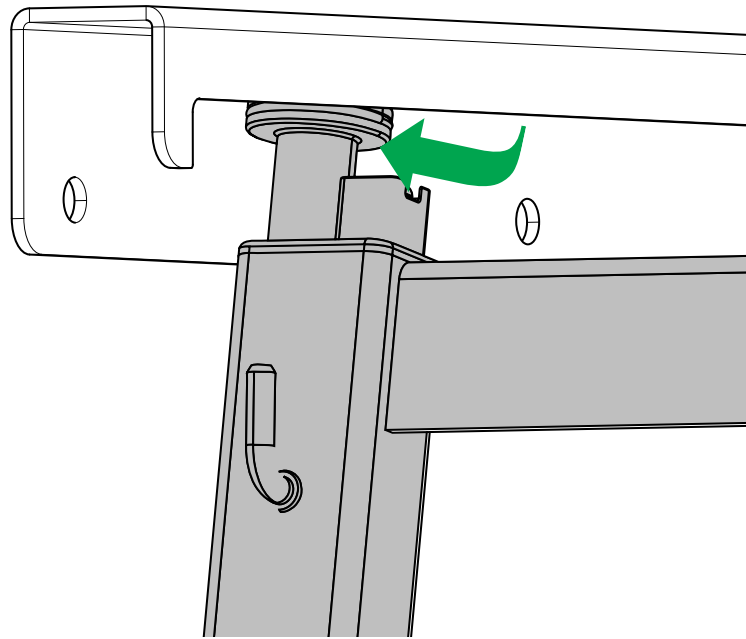

TANDEM diagonal junior

300 mm



6



1x

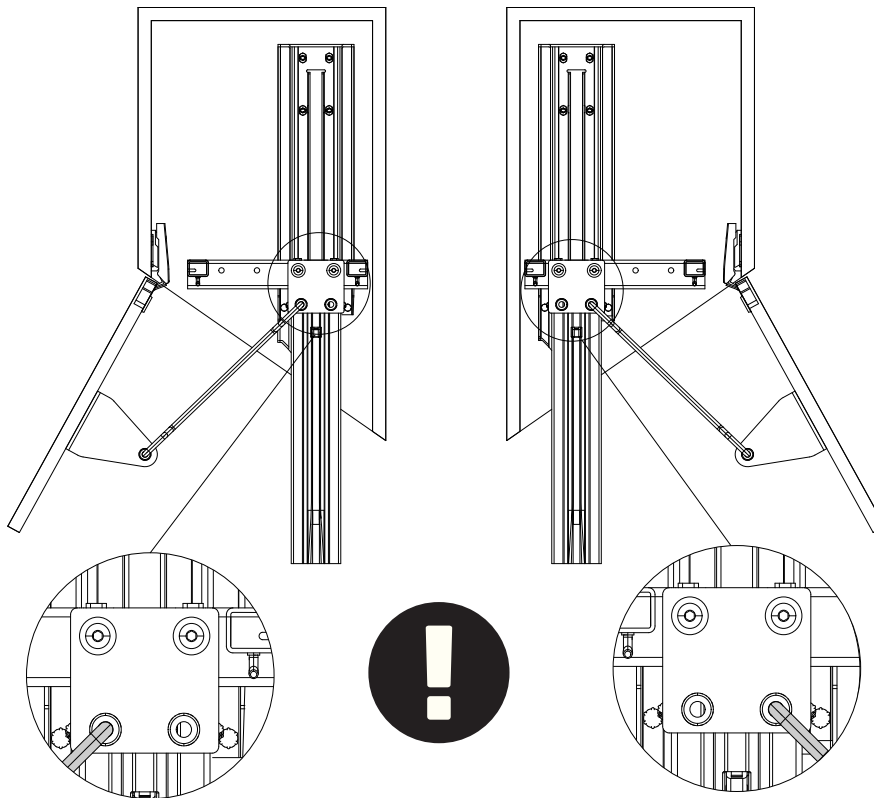

7

