

CONERO

Inside Pullout 72 H 482, Häfele UM A synchro

HÄFELE



KESSEBÖHMER



811.66.300
811.66.301
811.66.304
811.66.305
811.66.365
811.66.370
811.66.371
811.66.374

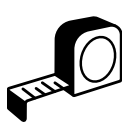
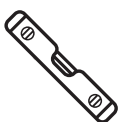
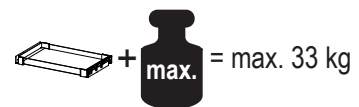
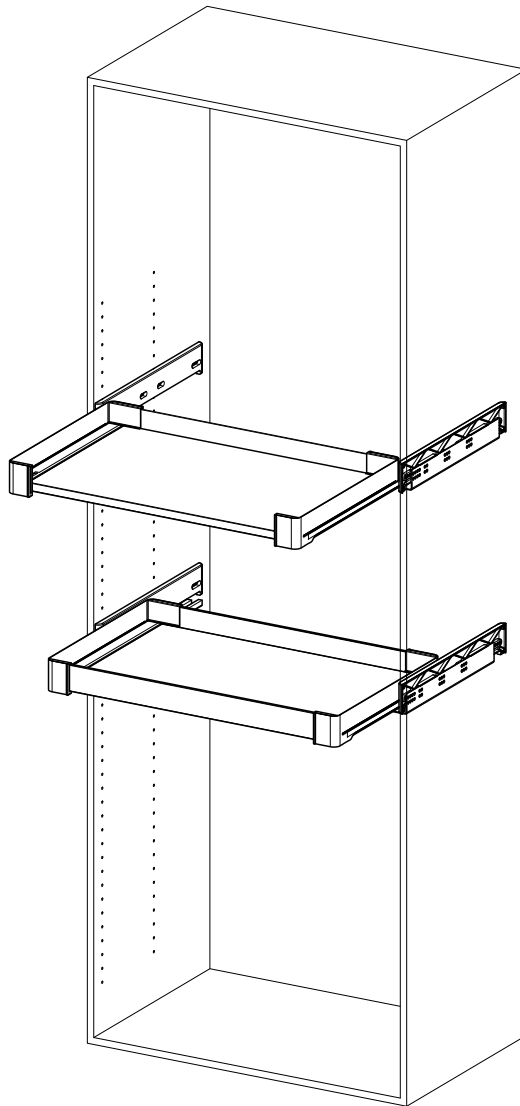

<http://support.kesseboehmer.de>



CONERO

Inside Pullout 72 H 482, Häfele UM A synchro

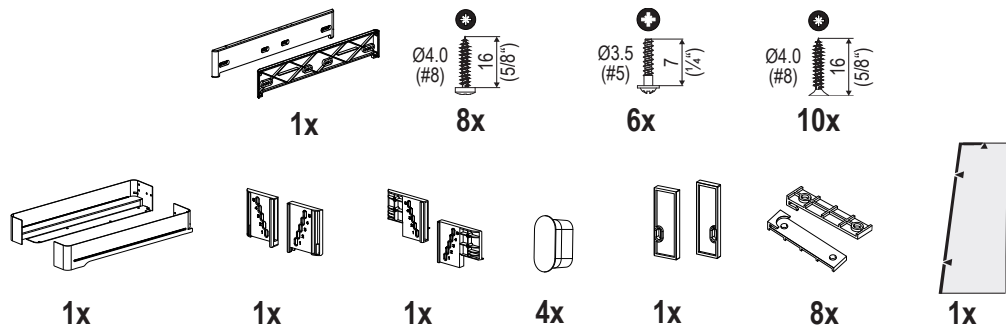
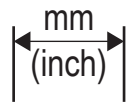
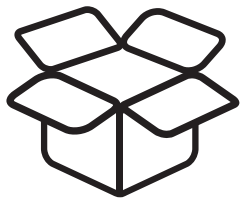

optional

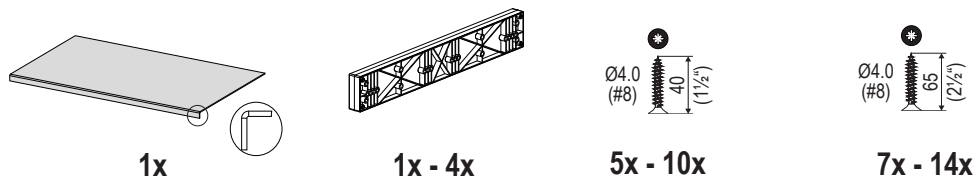

A

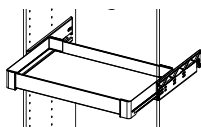

1x

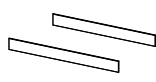

1x

B

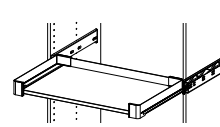

1x

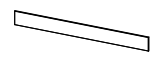

1x

DE Die technischen Darstellungen und Maßangaben – auch bei Abbildungen und Zeichnungen – sind unverbindlich. Konstruktionsverbesserungen sind vorbehalten! **EN** Technical information and stated dimensions (including in illustrations and drawings) must not be regarded as binding. Design subject to improvement without notice! **FR** Les visuels techniques et dimensions – y compris les schémas et les illustrations – ne sont pas contractuelles. Sous réserve d'évolutions techniques! **IT** Le rappresentazioni tecniche e le indicazioni delle dimensioni – anche nelle figure e nei disegni – non sono vincolanti. Con riserva di miglioramenti di progettazione! **ES** Las imágenes técnicas y las indicaciones de medidas – también en imágenes y dibujos – no son vinculantes. Queda reservado el derecho de realizar mejoras en el diseño! **PT** Representações técnicas e dimensões – mesmo em ilustrações e desenhos – não são vinculativas. Reservado o direito a melhorias construtivas! **HE** כל התרשימים הטכניים והמידות – אף לגבי איורים ותכניות – הנם בלתי מחייבים. זכות לשינויים ושיפורים מבניים שמורה ליצרן! **FI** Tekniset piirroksat ja mitat – myös kuvissa ja piirroksissa olevat – ovat sitoumuksetta. Oikeus rakennetta parantaviin muutoksiin pidätetään! **DA** De tekniske illustrationer og målangivelser – også på illustrationer og tegninger – er ikke bindende. Forbehold for designforbedringer! **CS** Technické popisy a rozměry, jakož i obrázky a výkresy, jsou nezávazné. Vyhrazujeme si právo na změny konstrukce! **PL** Prezentacje techniczne i wymiary – także na ilustracjach i rysunkach – nie są wiążące. Udoskonalenia konstrukcyjne są zastrzeżone! **RU** Иллюстрации технических деталей и указанные размеры, в том числе на рисунках и чертежах, являются ориентировочными. Компания оставляет за собой право на усовершенствование конструкции! **TR** Teknik sunum ve ölçü bilgileri (resim ve çizimlerde de) yasal olarak bağlayıcı değildir. Yapısal geliştirmeler yarma hakkı saklıdır! **BG** Техническото представяне и размерите, включително при изображенията и чертежите, са необвързващи. Запазваме си правото на конструктивни подобрения! **HU** A műszaki ábrázolások és méretadatok – ábránál és rajzoknál sem – nem kötelező érvényűek. A konstrukciós javítások joga fenntartva! **SR** Tehničke ilustracije i dimenzije – uključujući ilustracije i crteže – nisu obavezujući. Dizajn poboljšanja su rezervisana! **EL** Τα τεχνικά σχέδια και οι διαστάσεις – ακόμα και σε απεικονίσεις και σχέδια – δεν είναι δεσμευτικά. Με την επιφύλαξη τεχνικών βελτιώσεων! **JA** 図面の技術的および寸法的情報 – 図面や図紙に示された寸法情報を含む – は必ずしも拘束力を持ちません。改良設計の権利を留保します。 **CN** 技术说明和规格, 包括插图和图纸均不具约束力。保留改进设计的权利!

CONERO

Inside Pullout 72 H 482, Häfele UM A synchro



i

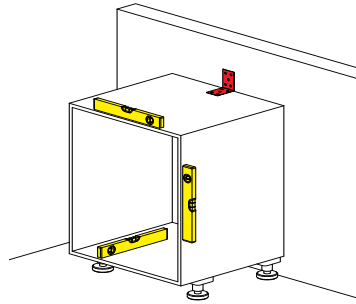
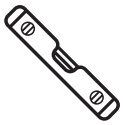

1

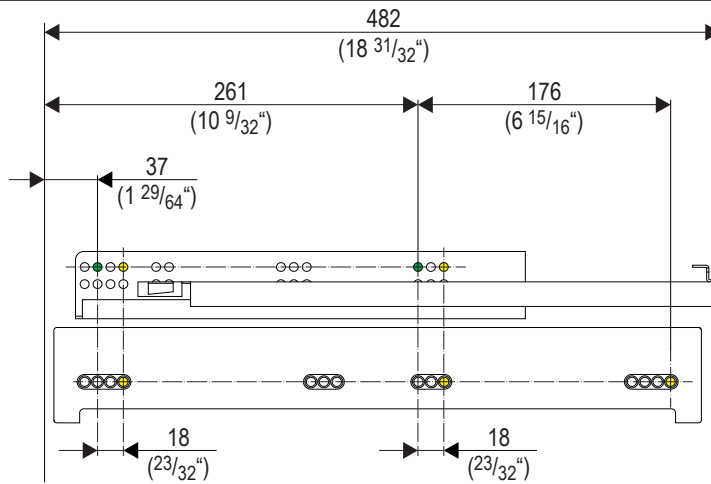
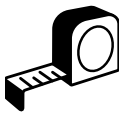

1a.1

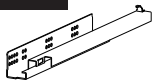

1x

PZ2

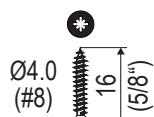

2x

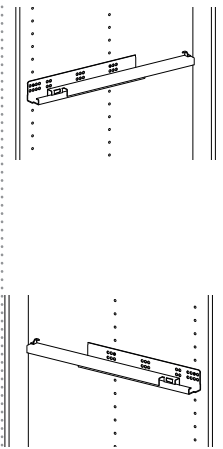
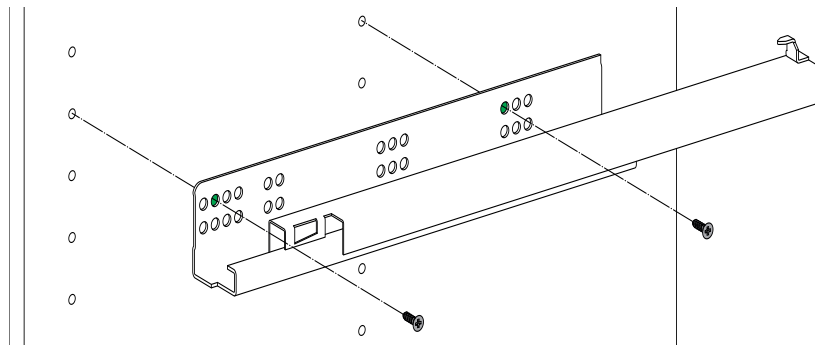

1a.2

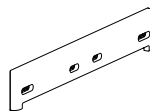

1x

PZ2

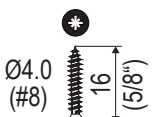

3x

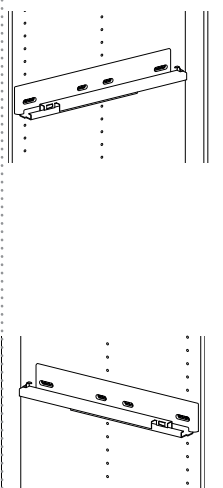
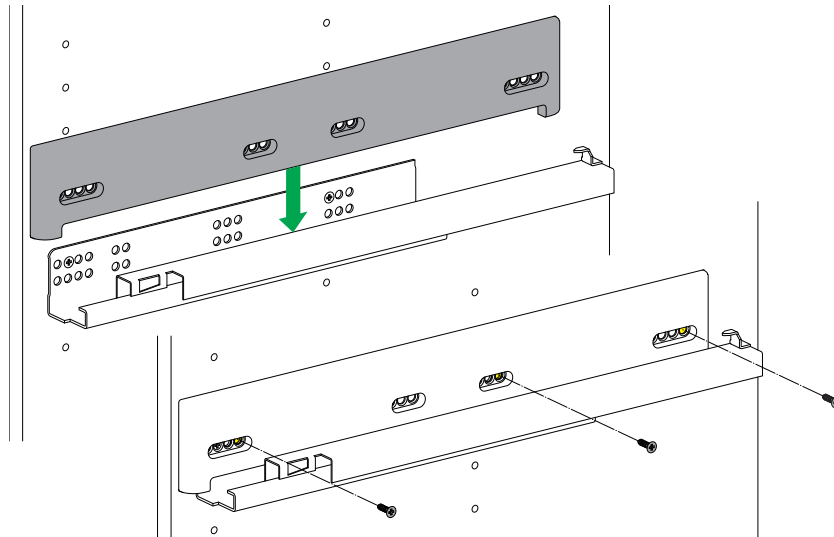

CONERO

Inside Pullout 72 H 482, Häfele UM A synchro



1b.1

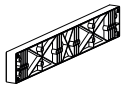

1x

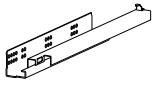

1x



PZ2

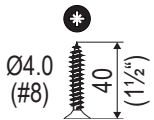

2x

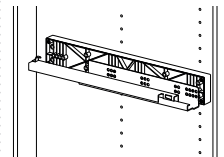
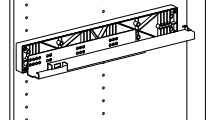
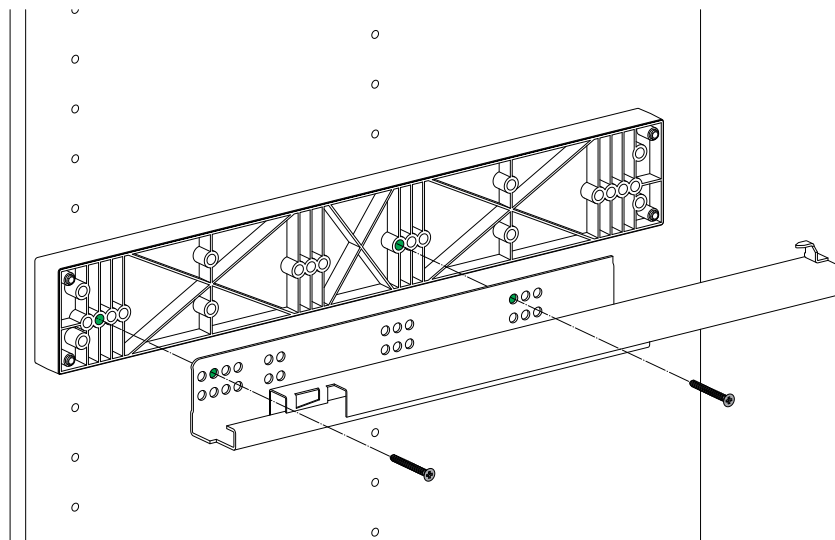

1b.2

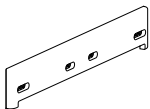

1x



PZ2

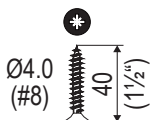

3x

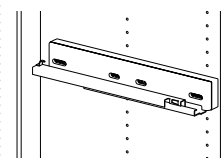
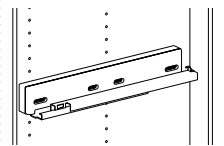
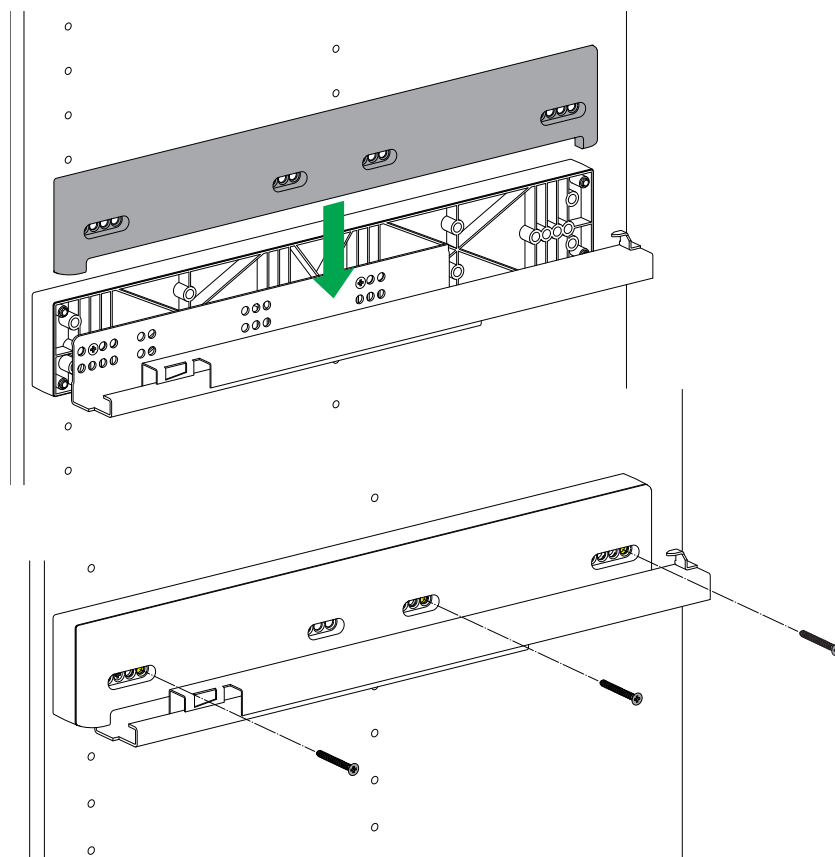

CONERO

Inside Pullout 72 H 482, Häfele UM A synchro



1c.1

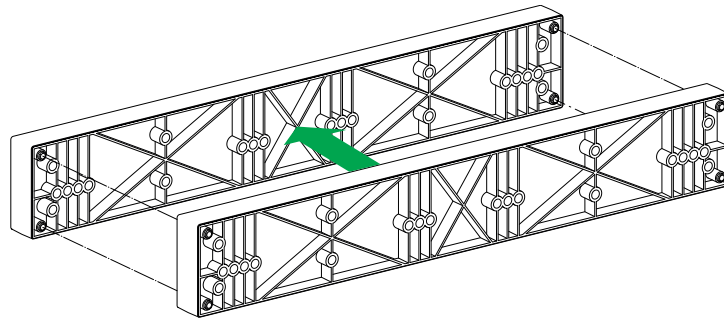
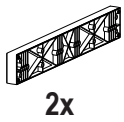

1c.2

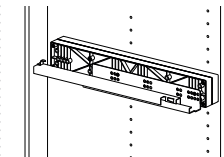
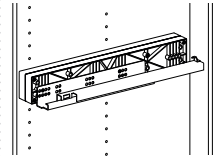
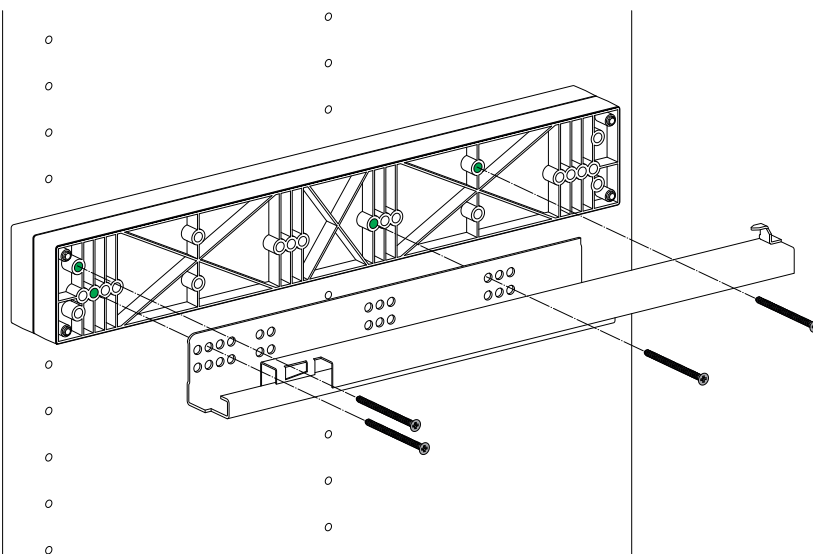
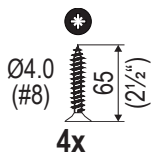
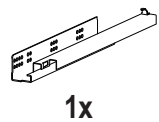
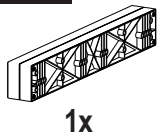

1c.3

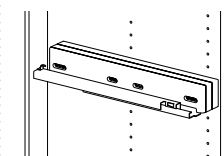
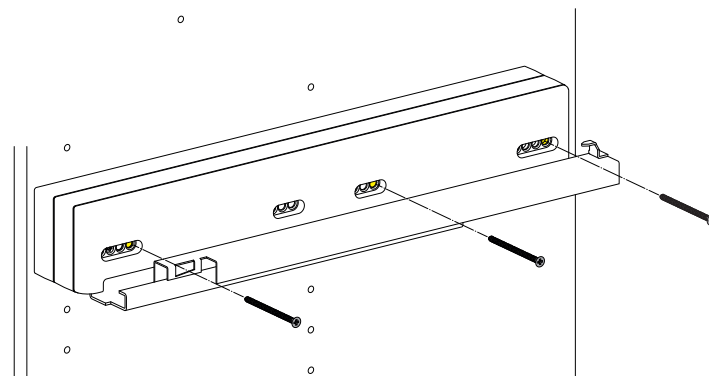
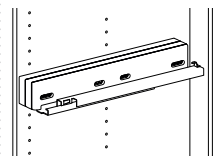
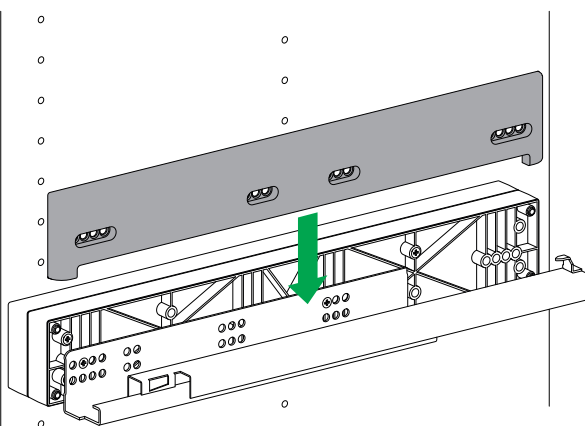
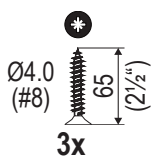
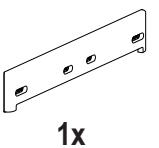

CONERO

Inside Pullout 72 H 482, Häfele UM A synchro



i

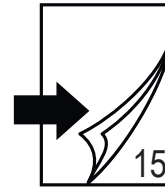
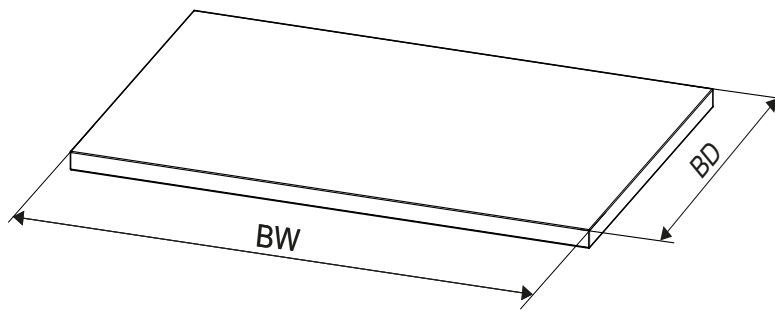

i

2

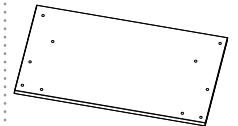
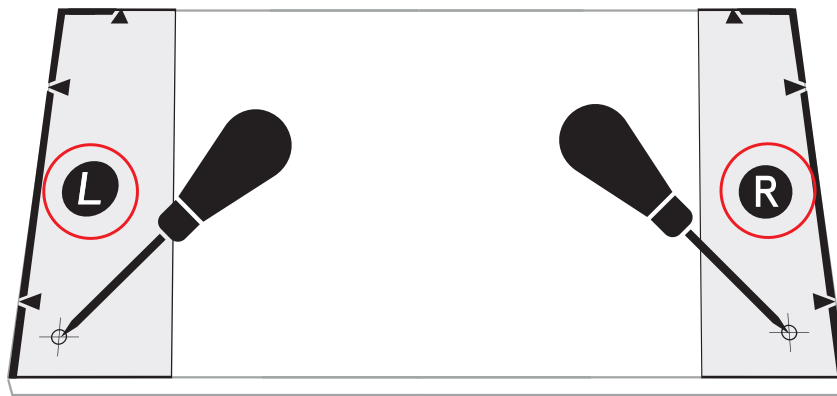
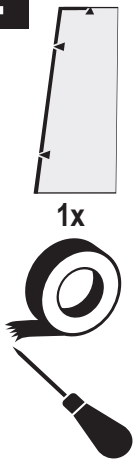

3a

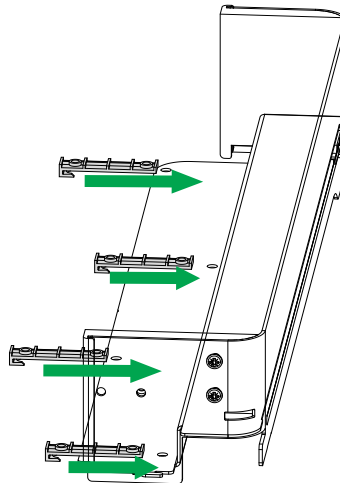
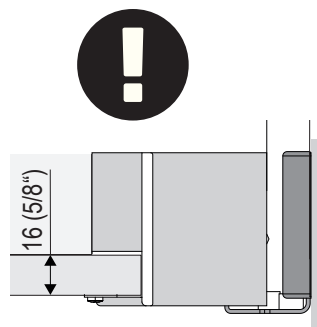
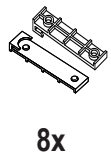

3b

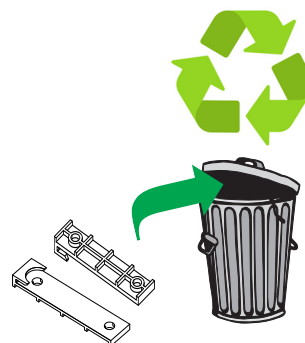
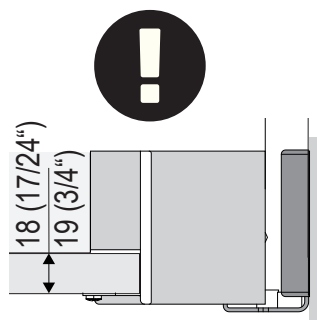
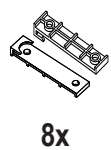

CONERO

Inside Pullout 72 H 482, Häfele UM A synchro



4

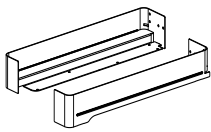

1x

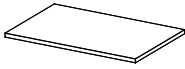

1x

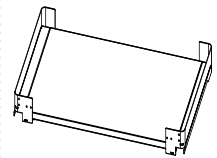
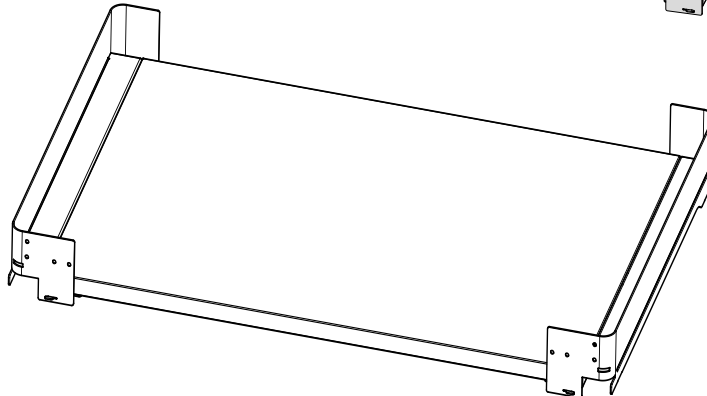
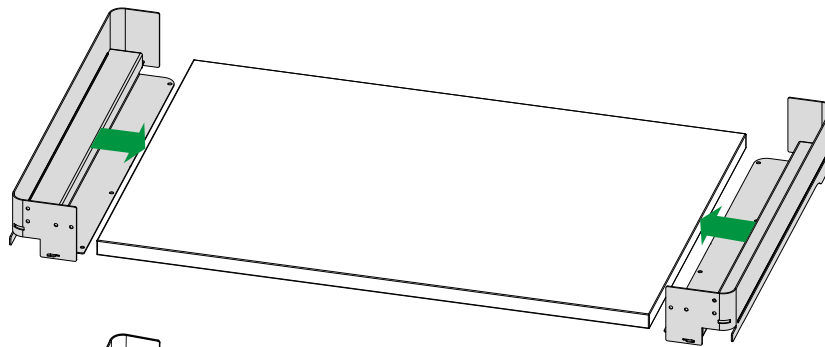

5a

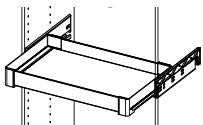

1x



1x

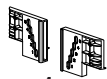

1x



1x

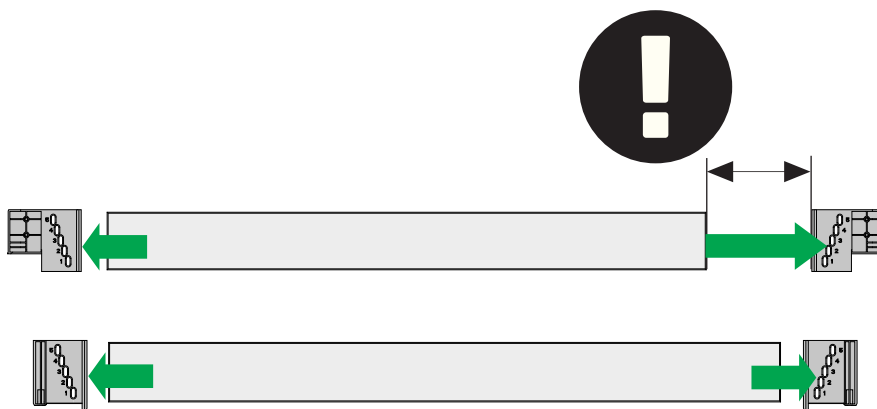

5b

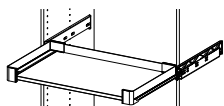

1x

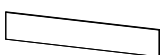

1x

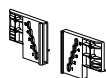

1x

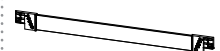

CONERO

Inside Pullout 72 H 482, Häfele UM A synchro



6.1

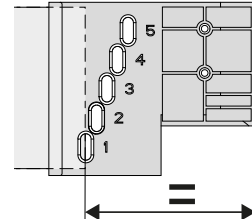
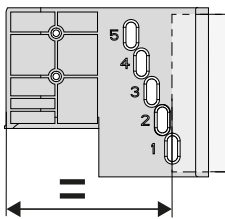
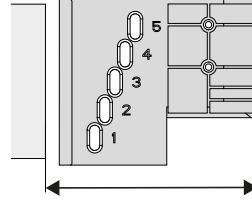
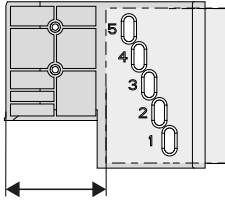
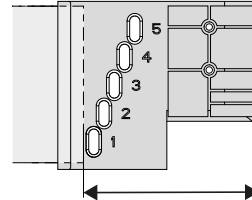
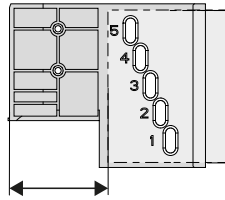
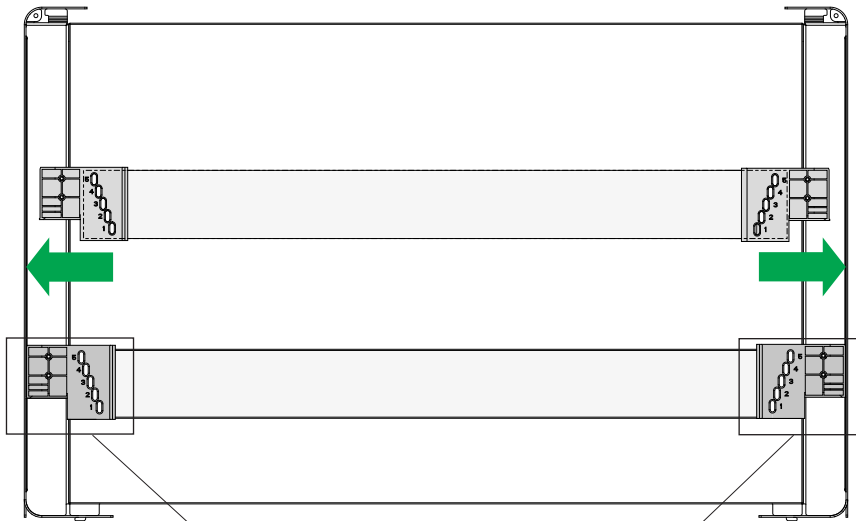

6.2a



1x



2x

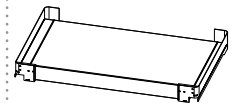
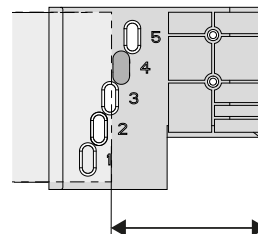
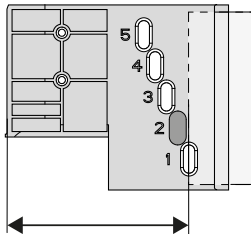
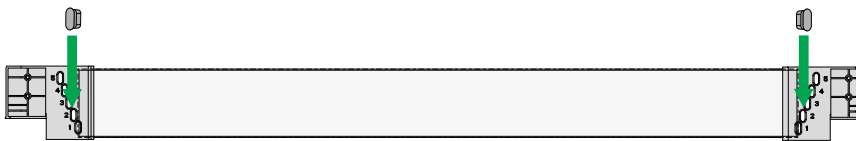

6.2b



2x

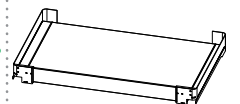
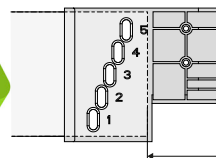
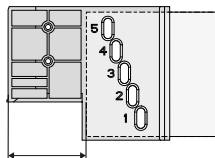

CONERO

Inside Pullout 72 H 482, Häfele UM A synchro



7.1

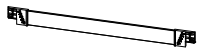

1x

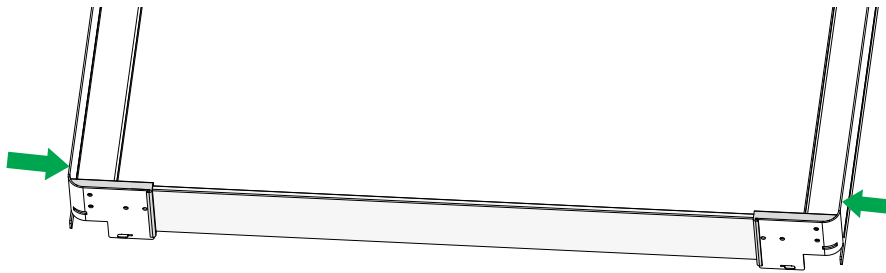

7.2

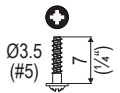

4x

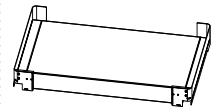
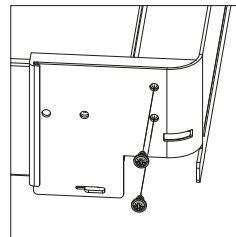
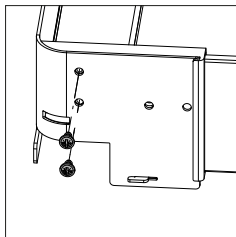
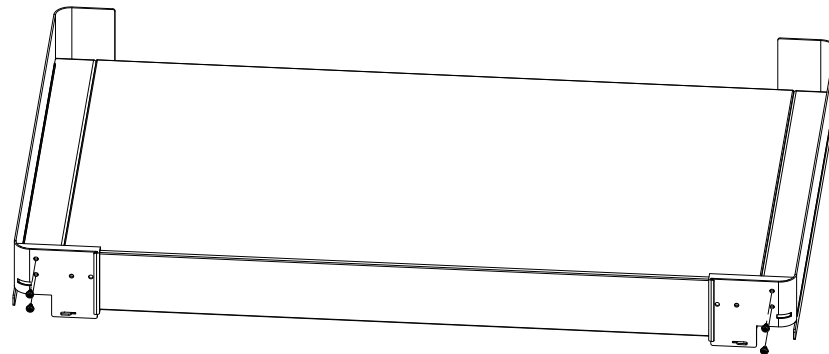

8.1

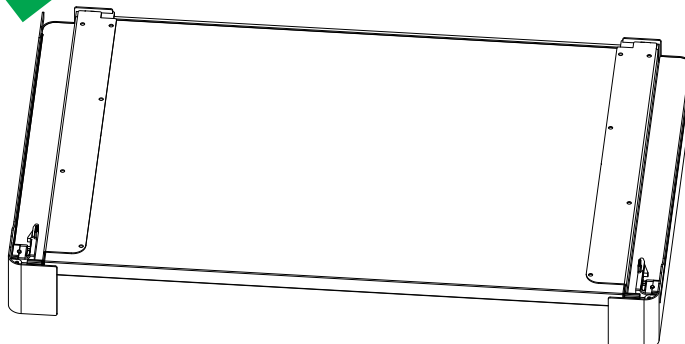
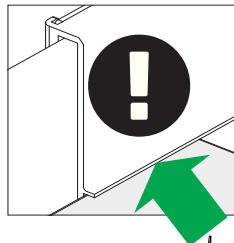
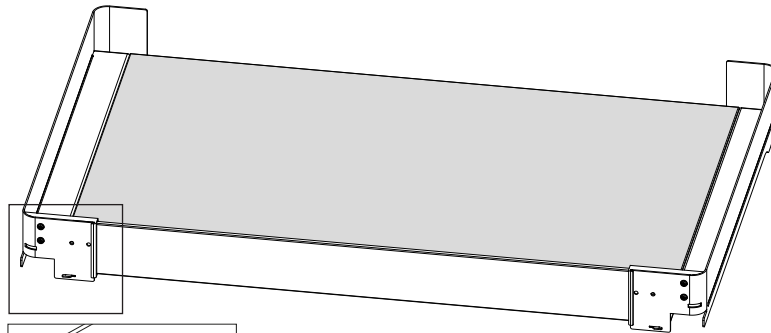

CONERO

Inside Pullout 72 H 482, Häfele UM A synchro



8.2

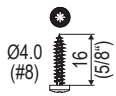

1x



1.

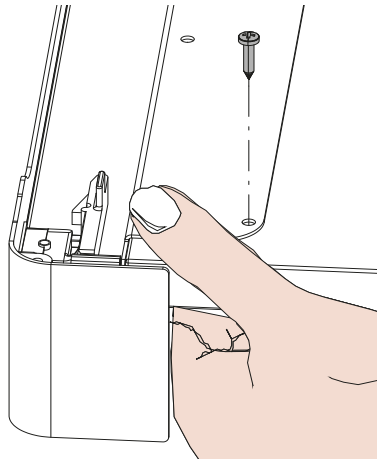

8.3

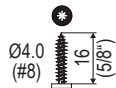

1x



2.

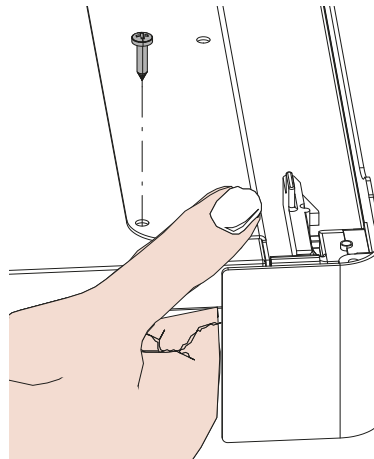

8.4

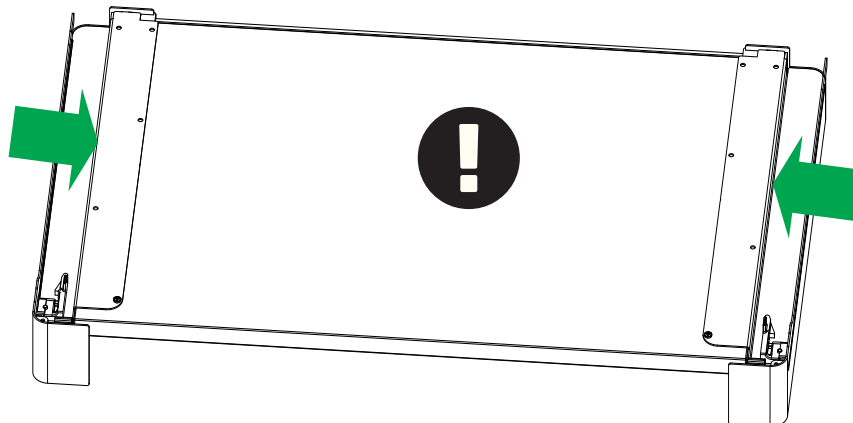

8.5

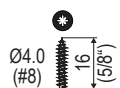

6x

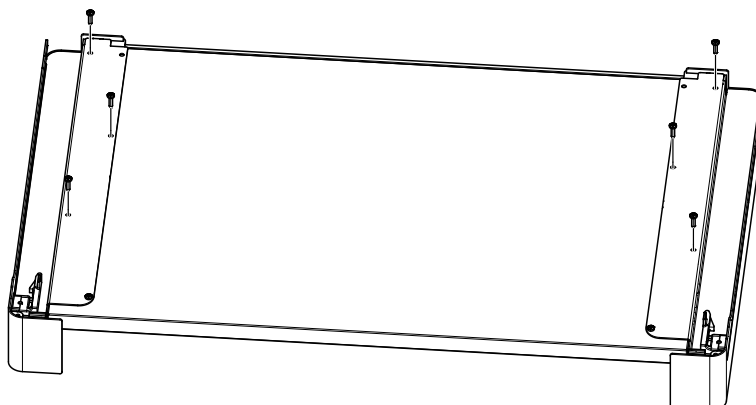

CONERO

Inside Pullout 72 H 482, Häfele UM A synchro



i

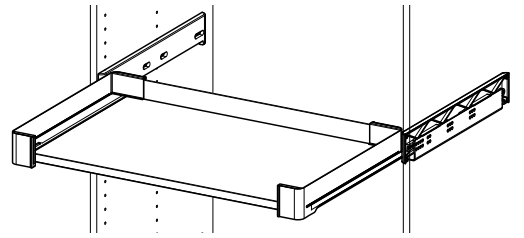
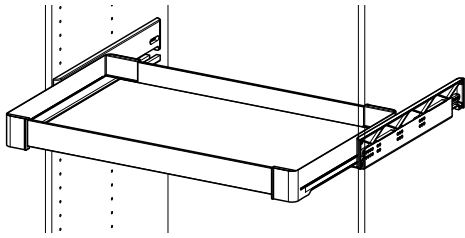

9a.1



11b

9a.1

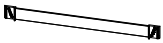
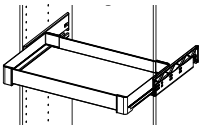

1x

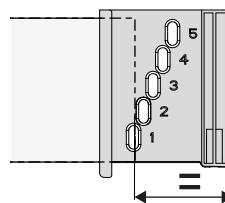
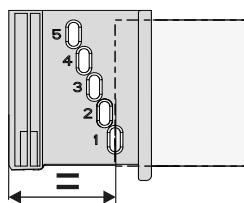
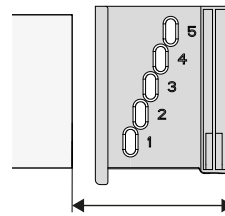
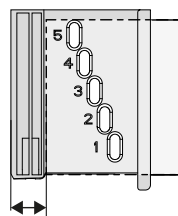
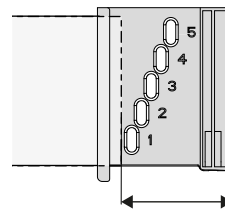
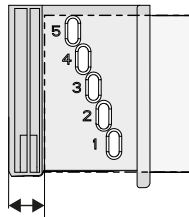
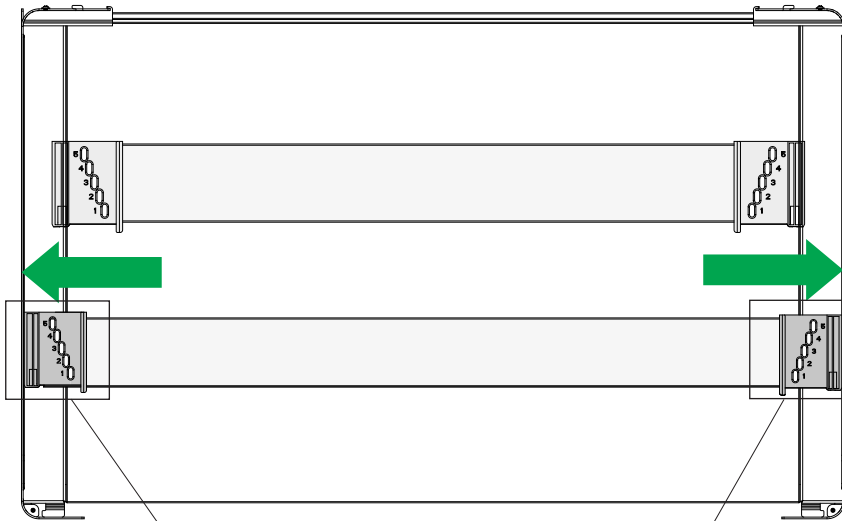

CONERO

Inside Pullout 72 H 482, Häfele UM A synchro



9a.2a



2x

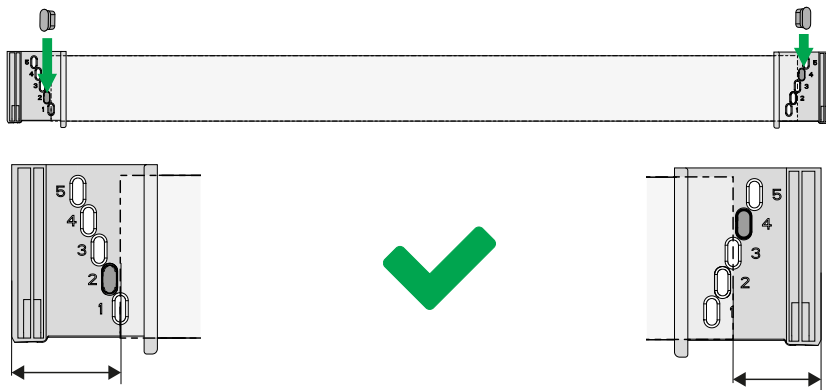

9a.2b



2x

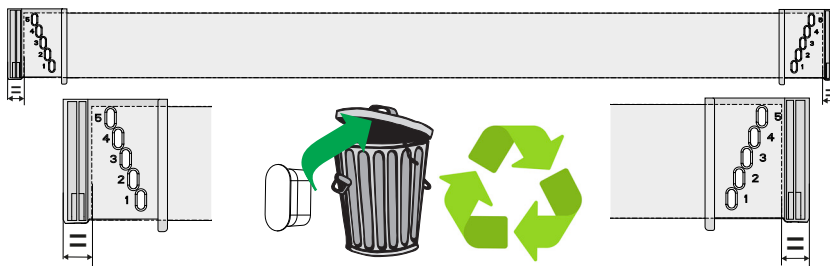

9a.3



2x



10a

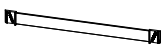

1x

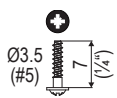

2x

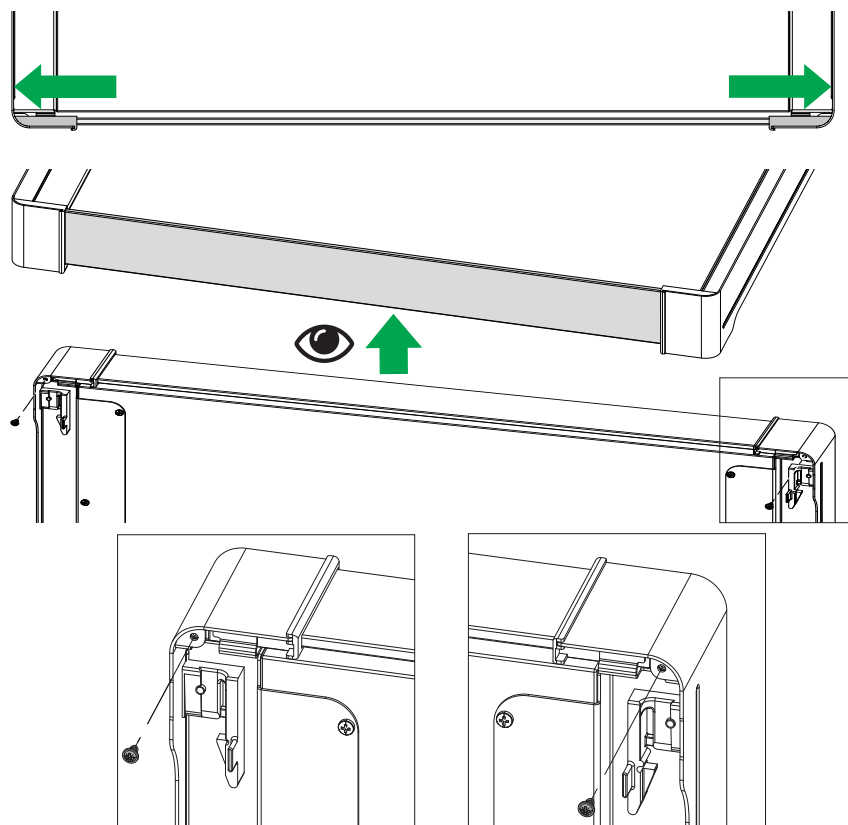

CONERO

Inside Pullout 72 H 482, Häfele UM A synchro



10b

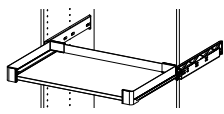

1x



1x



2x



2x

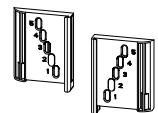
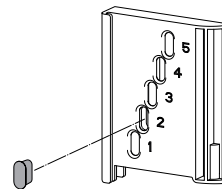
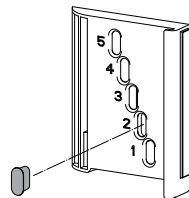
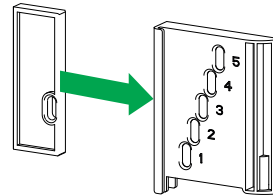
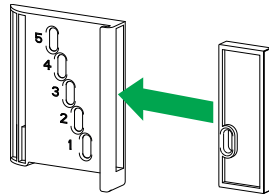

11b

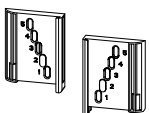

1x

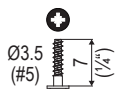

2x



PZ2

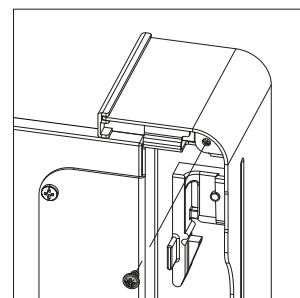
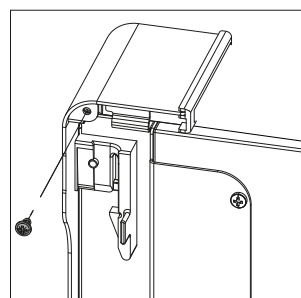
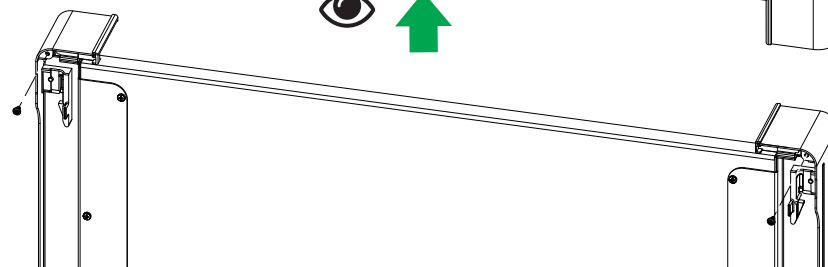
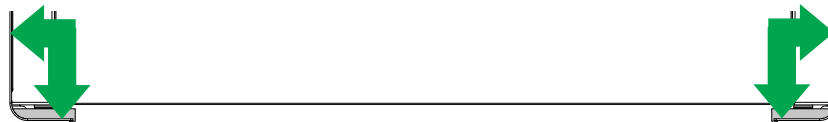

CONERO

Inside Pullout 72 H 482, Häfele UM A synchro



12

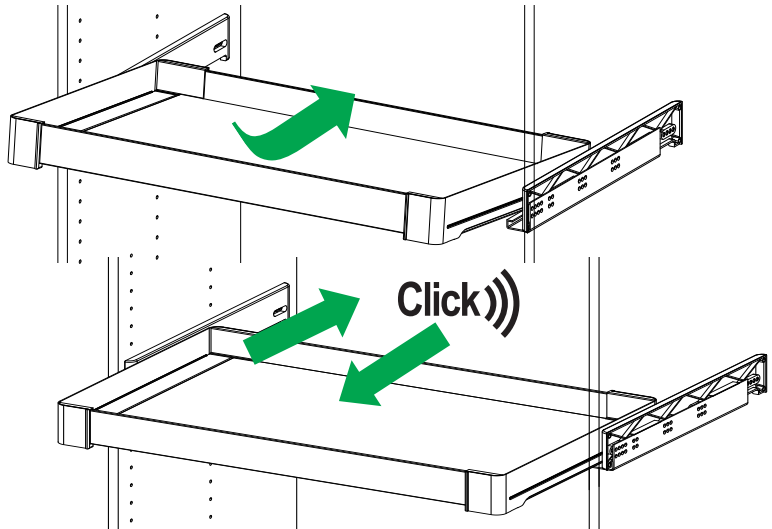

13.1

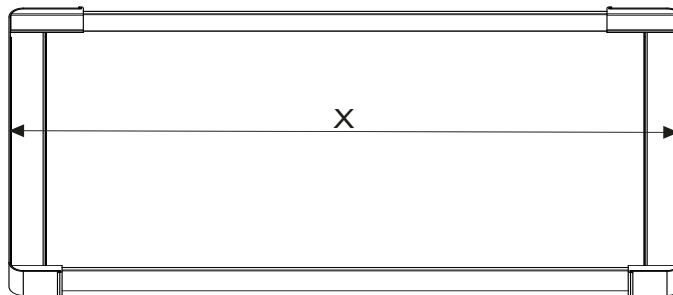
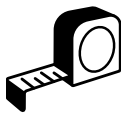

13.2

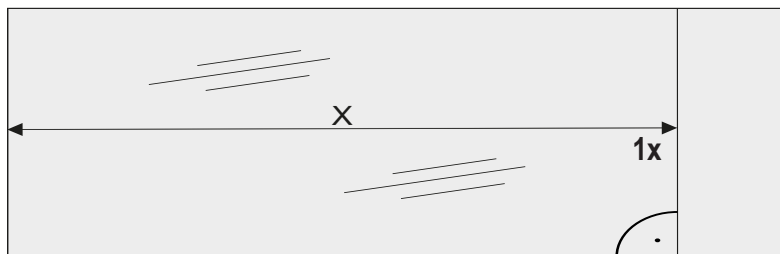
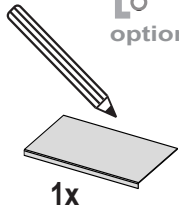

13.3

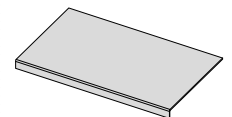

13.4

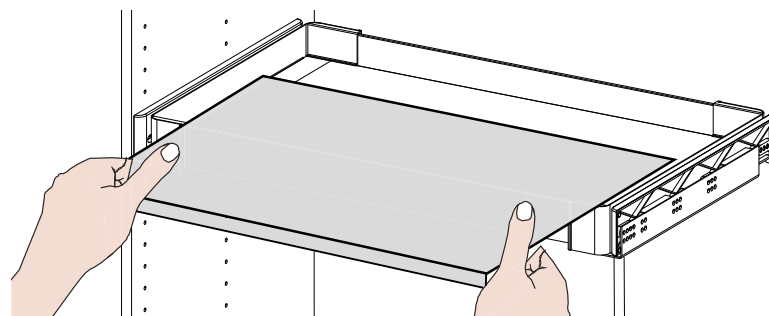
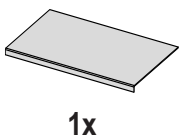

CONERO

Inside Pullout 72 H 482, Häfele UM A synchro

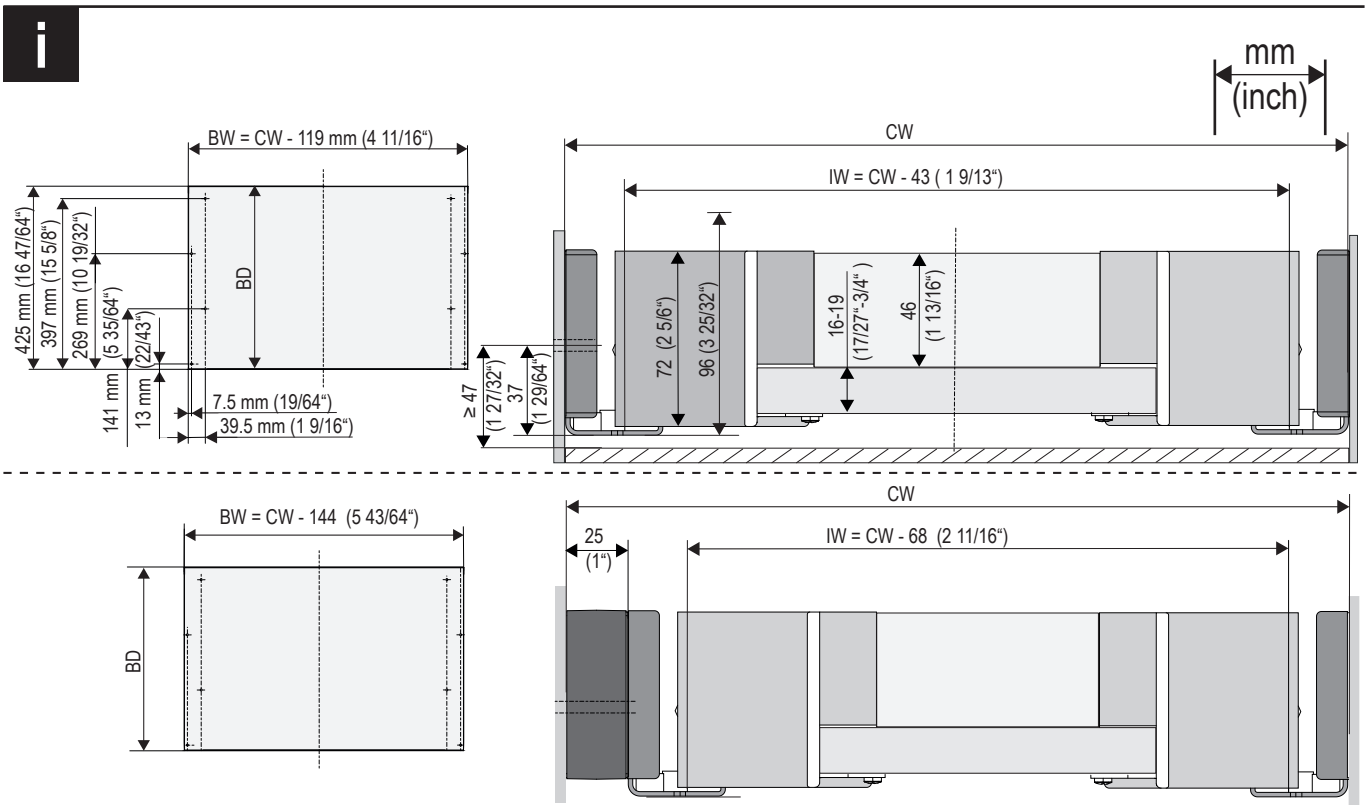
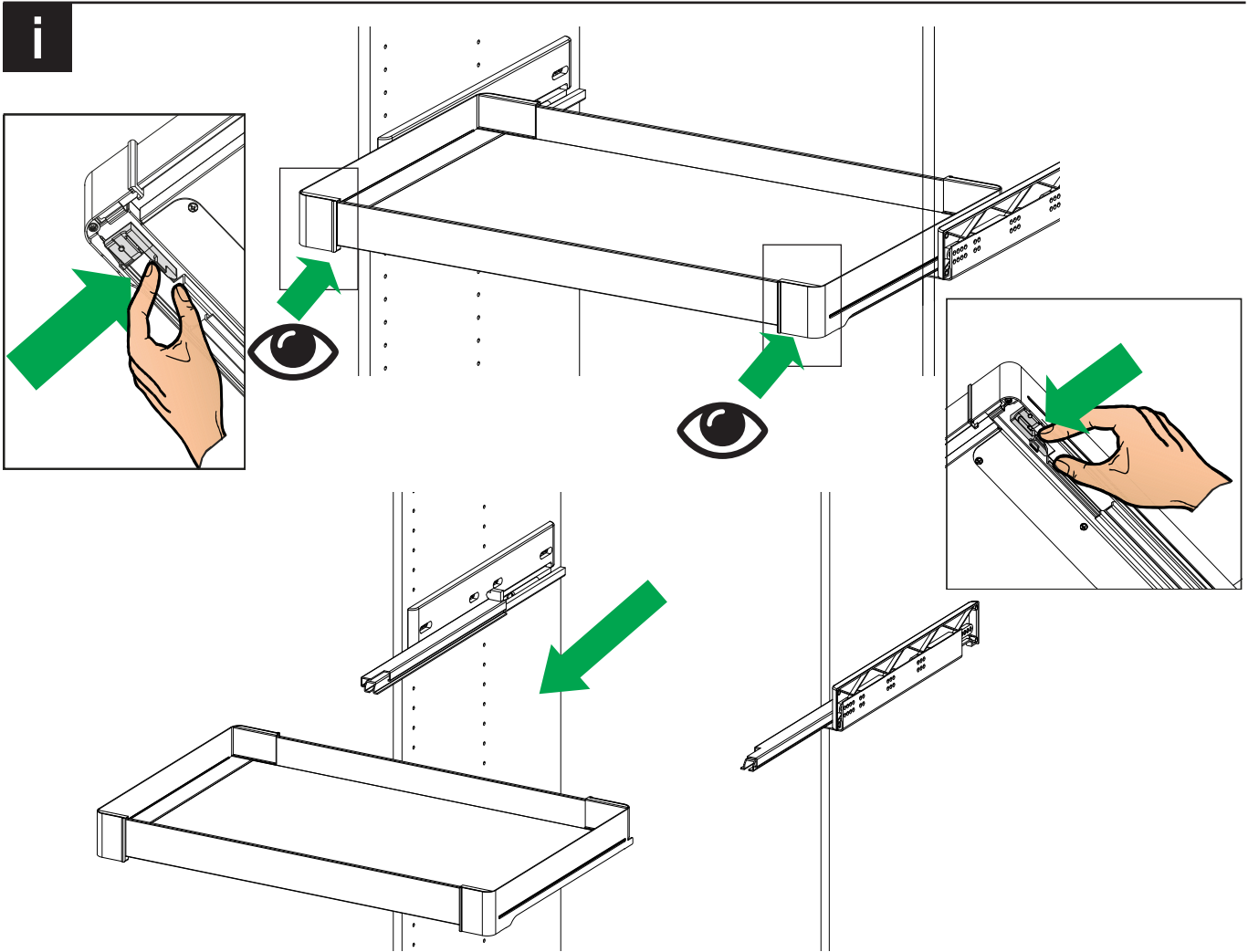

CONERO

Inside Pullout 72 H 482, Häfele UM A synchro



i

mm
(inch)

