

PUURIMISRAKIS

2

**KÄEPIDEMED**

3

alumiiniumviimistlus / kroom / nikkel

**KÄEPIDEMED / NUPUD**

10

kroom / nikkel / pronks

**NUPUD**

11

kroom / nikkel / alumiiniumviimistlus

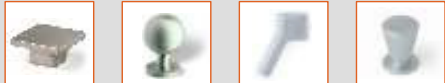
**KLAASUKSE KÄEPIDEMED**

13

kroom / nikkel

**KÄEPIDE**

13

klaasefekt

**SISSEFREESITAVAD KÄEPIDEMED**

14

kroom / nikkel / alumiiniumviimistlus

**REELINGKÄEPIDEMED**

16

alumiinium / nikkel

**KÄEPIDEMED / NUPUD**

17

alumiinium

**KÄEPIDEMED / NUPUD**

19

antiikpronks / pronks / antiikhõbe

**KÄEPIDEMED / NUPUD**

20

messing

**KÄEPIDEMED / NUPUD**

21

portselan / kombinatsioonid

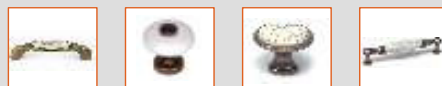
**KÄEPIDEMED / NUPUD**

22

nahk / kombinatsioonid

**NAGID**

23

kroom / nikkel / pronks / puit

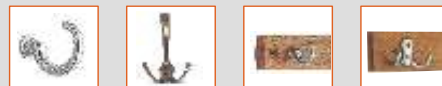
**FOTOD ON ILLUSTRATIIVSED!**

PUURIMISRAKIS

Art. 001.35.001 käepidemete ja nupu aukude puurimiseks

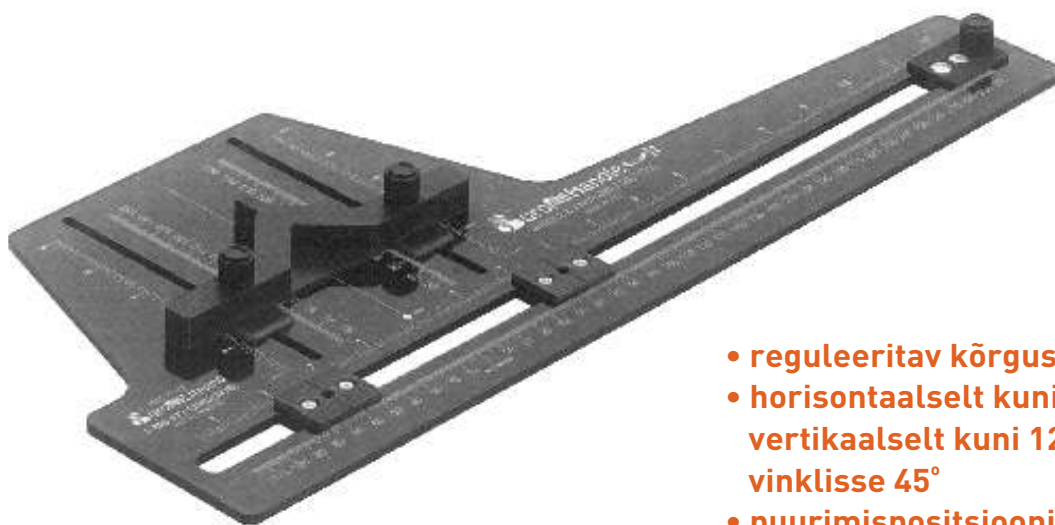

- reguleeritav kõrgus ja laius
- horisontaalselt kuni 420 mm
vertikaalselt kuni 125 mm
vinklisse 45°
- puurimispositsioonide
reguleerimine lükandi abil

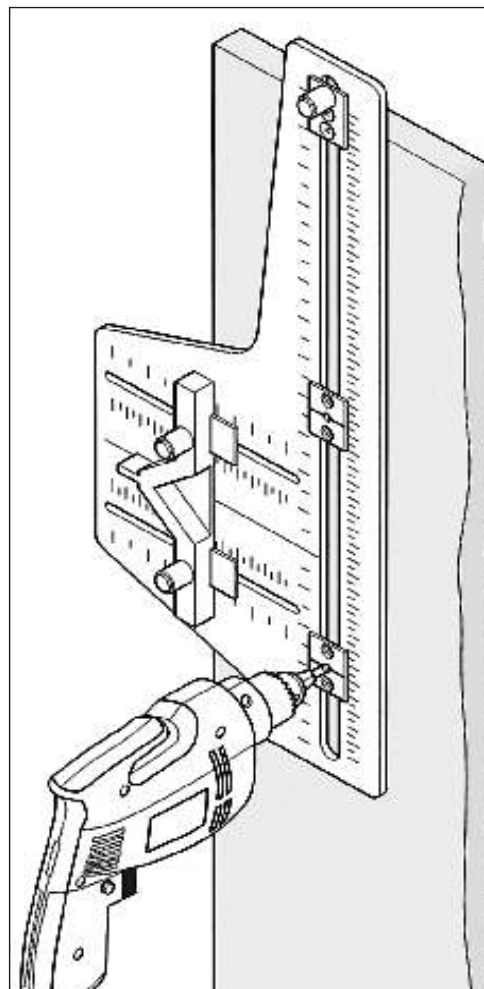
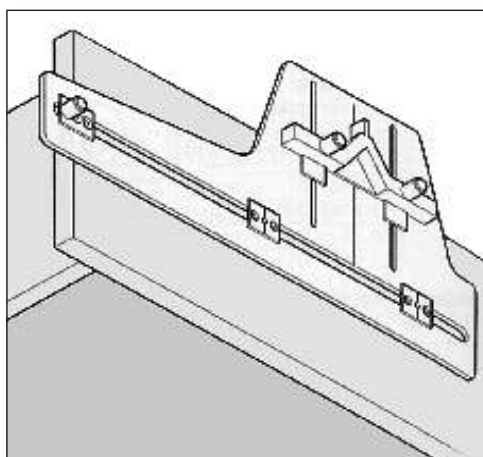
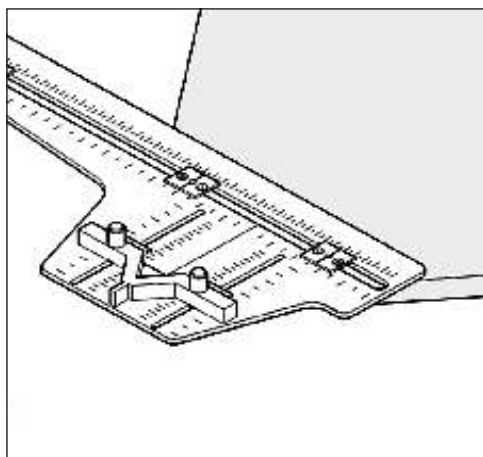

KÄEPIDEMED - kroom / nikkel

Art. 254 (31) **Tühistatud**
254 (52) **Tühistatud**

tsentrite vahe 32 mm
tsentrite vahe 32 mm

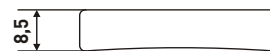
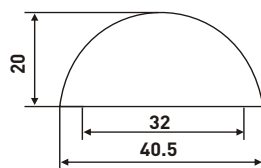

Art. 265 (31) matt kroom

tsentrite vahe 192 mm

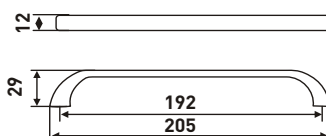
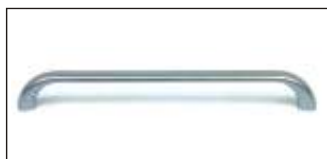

Art. 301 A (11) lihvitud nikkel
301 B (11) lihvitud nikkel

tsentrite vahe 192 mm
tsentrite vahe 128 mm

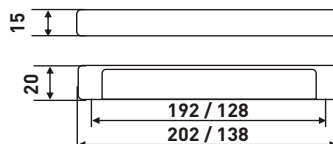

Art. 303 A (11) lihvitud nikkel
303 A (31) matt kroom

tsentrite vahe 192 mm
tsentrite vahe 192 mm

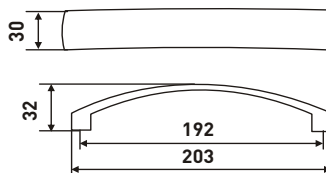

Art. 305 (11) lihvitud nikkel
305 (31) matt kroom
305 (33) matt nikkel-lakitud

tsentrite vahe 160 mm
tsentrite vahe 160 mm
tsentrite vahe 160 mm

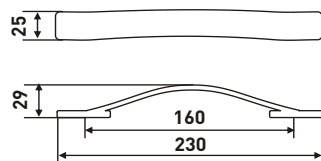

Art. 311 (31) matt kroom
311 (33) matt nikkel-lakitud
311 (52) matt must

tsentrite vahe 32 mm
tsentrite vahe 32 mm
tsentrite vahe 32 mm

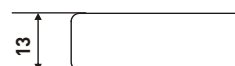
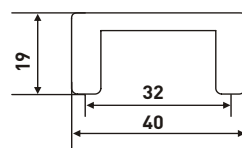

KÄEPIDEMED - kroom / nikkel

Art. 313 A (31) matt kroom
 313 B (31) matt kroom
 313 C (31) matt kroom
 313 D (31) **Tühistatud**

tsentrite vahe 160 mm
 tsentrite vahe 128 mm
 tsentrite vahe 96 mm
 tsentrite vahe 16 mm

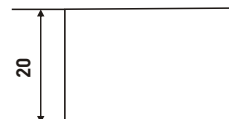
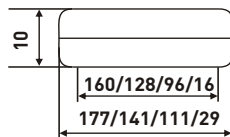

Art. 323 (11) lihvitud nikkel
 323 (31) matt kroom
 322 A (11) lihvitud nikkel
 322 A (31) matt kroom
 322 C (11) lihvitud nikkel
 322 C (31) matt kroom

tsentrite vahe 192/224 mm
 tsentrite vahe 192/224 mm
 tsentrite vahe 160 mm
 tsentrite vahe 160 mm
 tsentrite vahe 32 mm
 tsentrite vahe 32 mm

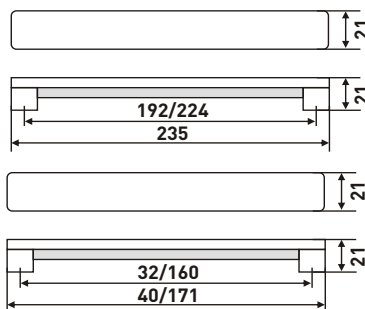

Art. 335 (31) **Tühistatud**

tsentrite vahe 96 mm

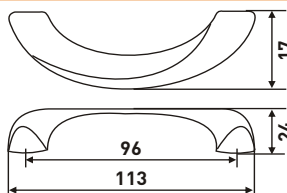

Art. 810-153 ZN4 **Tühistatud**

tsentrite vahe 128 mm



Art. 820-85 mm ZN4 **Tühistatud**

tsentrite vahe 64 mm

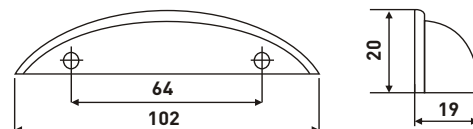

Art. 876-81 ZN4 **Tühistatud**
 876-119 ZN4 **Tühistatud**

tsentrite vahe 64 mm
 tsentrite vahe 96 mm

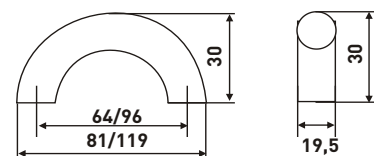

KÄEPIDEMED - kroom / nikkel

Art. 912-73 ZN1 **Tühistatud**
 912-73 ZN2 **Tühistatud**

tsentrite vahe 64 mm
 tsentrite vahe 64 mm

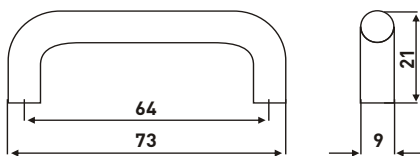

Art. 916-135 ZN1 kroom
 916-135 ZN4 matt nikkel
 916-135 ZN5 kuld
 916-135 ZN16 antratsiit

tsentrite vahe 96 mm
 tsentrite vahe 96 mm
 tsentrite vahe 96 mm
 tsentrite vahe 96 mm

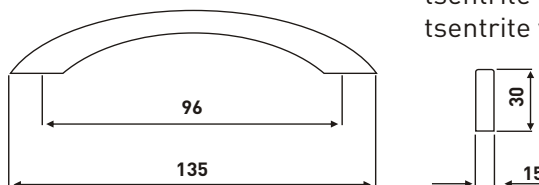

Art. 921-127 ZN1 **Tühistatud**
 921-127 ZN5 **Tühistatud**
 921-127 ZN10 pronks

tsentrite vahe 76 mm
 tsentrite vahe 76 mm
 tsentrite vahe 76 mm

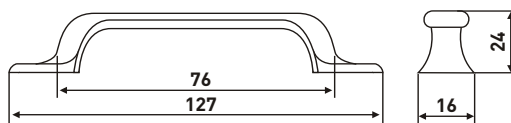

Art. 1026-135 ZN21 **Tühistatud**

tsentrite vahe 96 mm

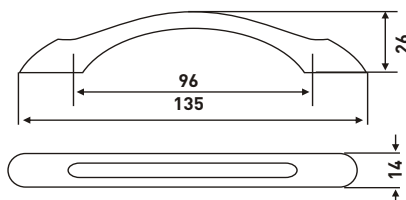

Art. 1029-147 ZN2 matt kroom
 1029-147 ZN21 lihvitud nikkel

tsentrite vahe 128 mm
 tsentrite vahe 128 mm

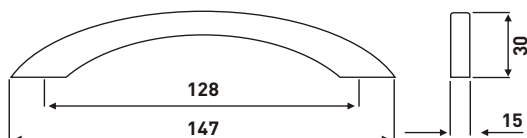

Art. 1143-137 ZN2 **Tühistatud**
 1146-204 ZN2 matt kroom
 1149-355 ZN2 matt kroom

tsentrite vahe 96 mm
 tsentrite vahe 192 mm
 tsentrite vahe 320 mm

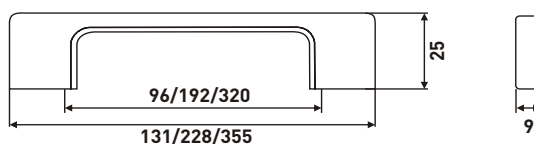
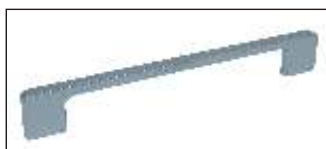

KÄEPIDEMED - kroom / nikkel / alumiiniumviimistlus
Art. 4208-170 ZN2 matt kroom

tsentrite vahe 160 mm

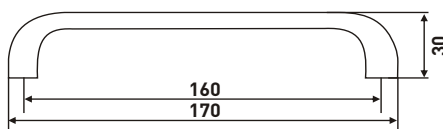

Art. 4408-140 ZN2 matt kroom

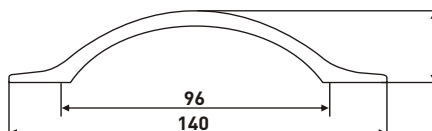
tsentrite vahe 96 mm

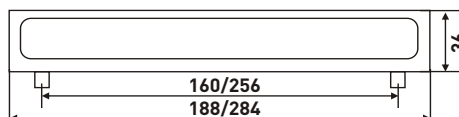
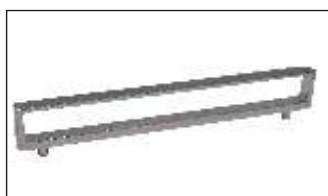

Art. 6607-188 ZN21 **Tühistatud**
6607-284 ZN21 **Tühistatud**

tsentrite vahe 160 mm

tsentrite vahe 256 mm

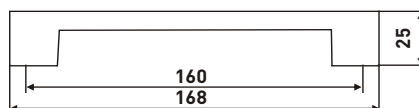
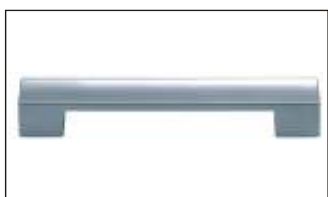

Art. 0408/160 ZN2 matt kroom

tsentrite vahe 160 mm

Art. 1706/128 ZN4 matt nikkel
1707/128 ZN21 lihvitud nikkel

tsentrite vahe 128 mm

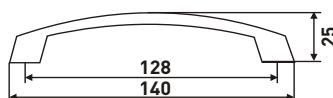
tsentrite vahe 128 mm

Art. 8306/96 ZN4 matt nikkel
8307/96 ZN21 lihvitud nikkel
8308/96 ZN2 matt kroom
8306/128 ZN4 matt nikkel
8307/128 ZN21 lihvitud nikkel
8308/128 ZN2 matt kroom

tsentrite vahe 96 mm

tsentrite vahe 96 mm

tsentrite vahe 96 mm

tsentrite vahe 128 mm

tsentrite vahe 128 mm

tsentrite vahe 128 mm

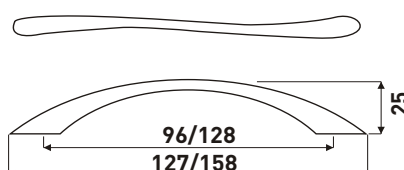

KÄEPIDEMED - kroom / nikkel

Art. 9007/96 ZN21 lihvitud nikkel
 9008/96 ZN2 matt kroom
 9007/128 ZN21 lihvitud nikkel
 9008/128 ZN2 matt kroom

tsentrite vahe 96 mm
 tsentrite vahe 96 mm
 tsentrite vahe 128 mm
 tsentrite vahe 128 mm

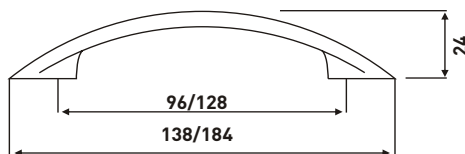

Art. 9408/128 ZN2 matt kroom

tsentrite vahe 128 mm

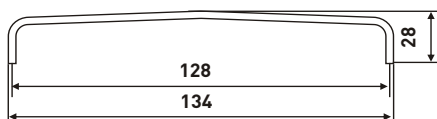

Art. 17.23.200 kroom

17.23.201 matt nikkel
 17.23.210 kroom
 17.23.211 matt nikkel
 17.23.212 kuld
 17.23.213 matt kroom
 17.23.216 kroom
 17.23.218 matt nikkel
 17.23.219 matt kroom

tsentrite vahe 64 mm
 tsentrite vahe 64 mm
 tsentrite vahe 96 mm
 tsentrite vahe 96 mm
 tsentrite vahe 96 mm
 tsentrite vahe 128 mm
 tsentrite vahe 128 mm
 tsentrite vahe 128 mm

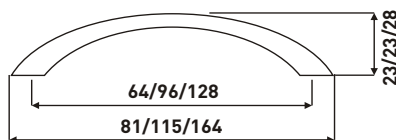

Art. 17.23.297 **Tühistatud**

tsentrite vahe 128 mm

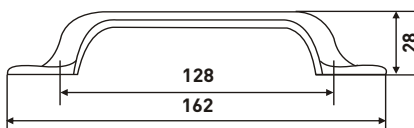

Art. 17.23.400 **Tühistatud**

tsentrite vahe 128 mm

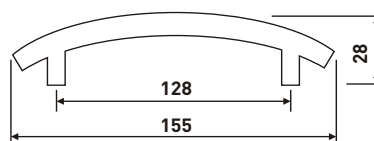

KÄEPIDEMED - kroom / nikkel

Art. 17.23.933 kroom
17.23.937 matt nikkel

tsentrite vahe 128 mm

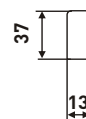
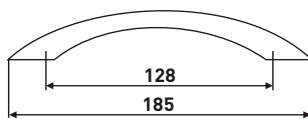

Art. 17.23.942 **Tühistatud**

tsentrite vahe 128 mm

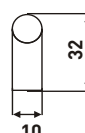
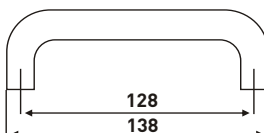

Art. 101.12.904 alumiiniumviimistlus

tsentrite vahe 160 mm

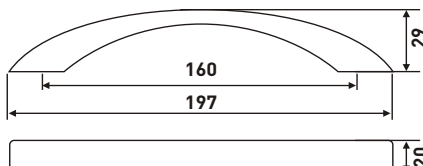

Art. 102.04.600 matt nikkel

tsentrite vahe 128 mm

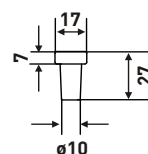
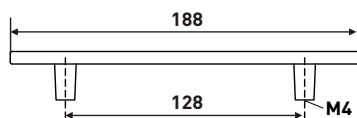
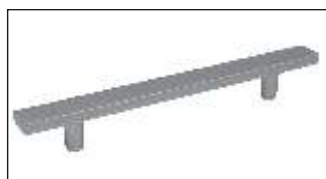

Art. 102.27.210 kroom
102.27.220 kroom
102.27.310 matt must
102.27.320 matt must
102.27.410 matt kroom
102.27.420 matt kroom

tsentrite vahe 96 mm
tsentrite vahe 128 mm
tsentrite vahe 96 mm
tsentrite vahe 128 mm
tsentrite vahe 96 mm
tsentrite vahe 128 mm

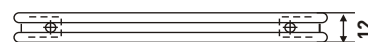
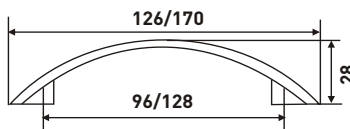

Art. 103.33.402 lihvitud nikkel

tsentrite vahe 128 mm

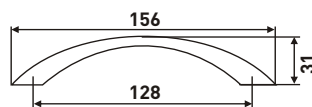

KÄEPIDEMED - kroom / nikkel / alumiiniumviimistlus
Art. 109.50.904 Tühistatud

tsentrite vahe 128 mm

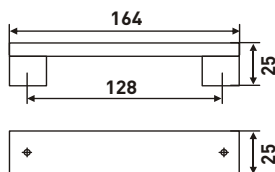
Art. 110.41.400 matt kroom
110.41.401 matt kroom
110.41.403 matt kroom
110.41.405 matt kroom

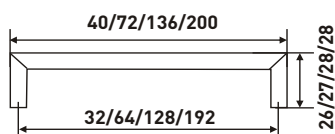
 tsentrite vahe 32 mm
 tsentrite vahe 64 mm
 tsentrite vahe 128 mm
 tsentrite vahe 192 mm

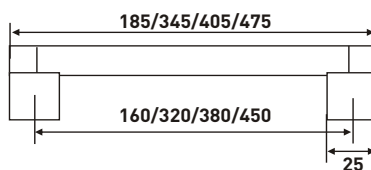
Art. 110.75.903 alumiiniumviimistlus
110.75.906 alumiiniumviimistlus
110.75.907 alumiiniumviimistlus
110.75.908 alumiiniumviimistlus

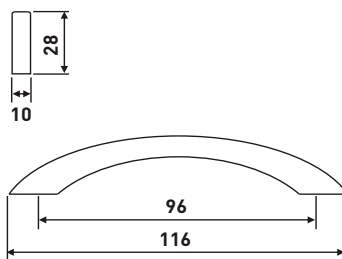
 tsentrite vahe 160 mm
 tsentrite vahe 320 mm
 tsentrite vahe 380 mm
 tsentrite vahe 450 mm

Art. 117.31.226 kroom
117.31.326 must
117.31.426 matt kroom
117.31.826 kuld

 tsentrite vahe 96 mm
 tsentrite vahe 96 mm
 tsentrite vahe 96 mm
 tsentrite vahe 96 mm

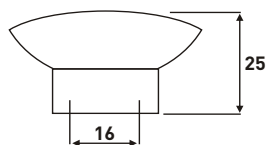
KÄEPIDEMED / NUPUD - kroom / nikkel / pronks

Art. A-077. ZN4 matt nikkel



Art. C-313. ZN4 matt nikkel
C-314. ZN4 matt nikkel

tsentrite vahe 96 mm
tsentrite vahe 128 mm

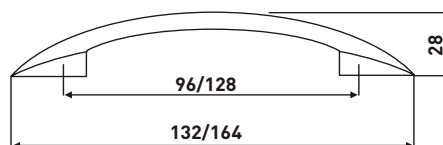

Art. 873-28 ZN2 matt kroom
873-28 ZN4 matt nikkel
873-28 ZN10 pronks

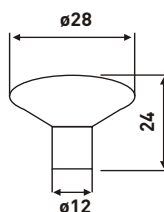

Art. 878-128 ZN2 matt kroom
878-128 ZN4 matt nikkel
878-128 ZN10 pronks
878-160 ZN2 matt kroom
878-160 ZN4 matt nikkel

tsentrite vahe 96 mm
tsentrite vahe 96 mm
tsentrite vahe 96 mm
tsentrite vahe 128 mm
tsentrite vahe 128 mm

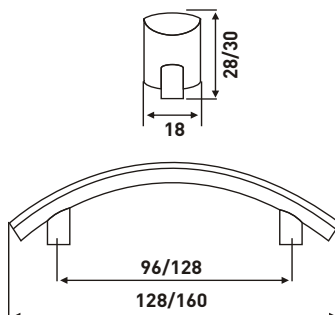

Art. 312 (10) Tühistatud
312 (11) Tühistatud
312 (31) Tühistatud
312 (52) Tühistatud

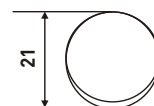
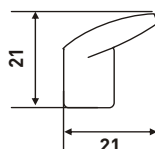

NUPUD - kroom / nikkel

Art. 314 (11) **Tühistatud**
 314 (31) **Tühistatud**

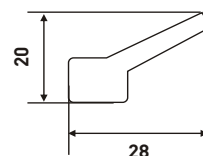
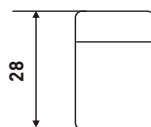

Art. 646-18 MS1 kuld
 646-18 MS4 kroom
 646-18 MS9 lihvitud nikkel

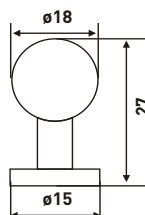

Art. 904-12 N1 lihvitud nikkel

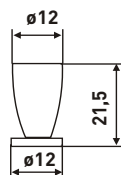

Art. 913-32 ZN1 kroom
 913-32 ZN2 matt kroom

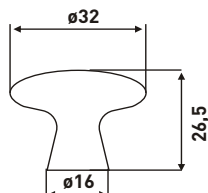

Art. 920-28 ZN1 **Tühistatud**
 920-28 ZN2 matt kroom
 920-28 ZN10 pronks

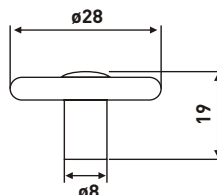

Art. 1581-16 ZN21 **Tühistatud**
 1581-16 PB21 **Tühistatud**

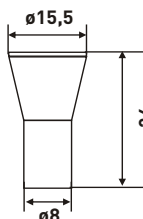

NUPUD - kroom / nikkel / alumiiniumviimistlus

Art. 1583-16 ZN21 lihvitud nikkel
 1583-16 PB21 alumiiniumviimistlus

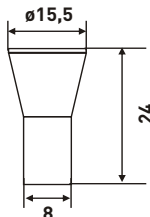

Art. 2004 (31) matt kroom
 2004 (52) **Tühistatud**

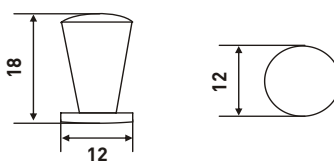

Art. 2033 (11) lihvitud nikkel
 2033 (31) matt kroom

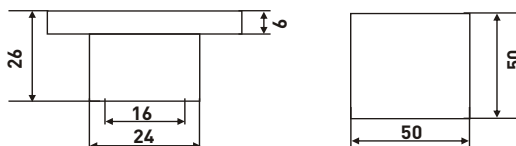

Art. 2036 (11) lihvitud nikkel
 2036 (31) matt kroom

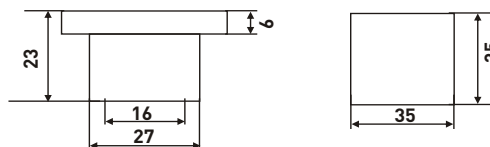

Art. 4408-20 ZN2 **Tühistatud**

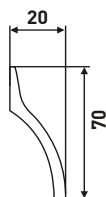

Art. 135.95.003 lihvitud nikkel
 135.93.903 alumiiniumviimistlus

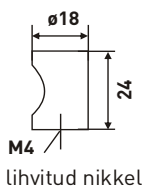

lihvitud nikkel

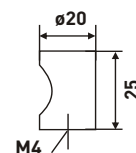

alumiiniumviimistlus

KLAASUKSE KÄEPIDEMED - kroom / nikkel

Art. 22.03.015 kroom

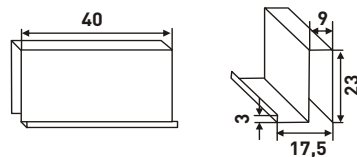

Art. 154.22.717 nikkel
154.22.313 matt must

klaasuksele 4-6 mm
kinnituskrugi - metall

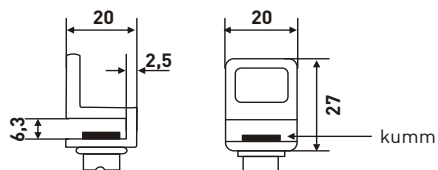

Art. 154.25.210 kroom

klaasuksele 5 mm
kinnituskrugi - metall

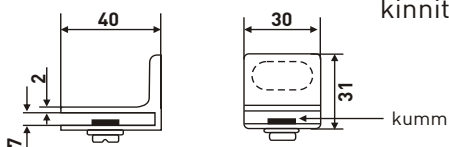

KÄEPIDE - klaasefekt

Art. PG9-206 GE2 ZN2 klaasefekt/matt kroom

tsentrite vahe 128 mm

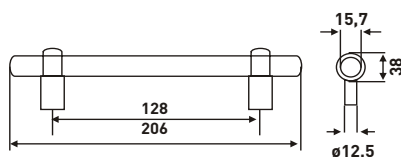

SISSEFREESITAVAD KÄEPIDEMED - kroom / nikkel
Art. 0203 kuld

0207 lihvitud nikkel

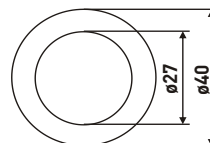
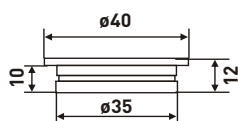
0208 matt kroom

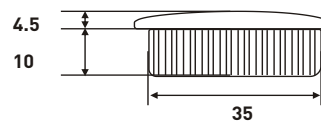
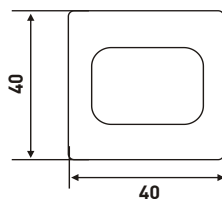
Art. 261 (11) lihvitud nikkel

261 (31) matt kroom

Art. 307 (11) lihvitud nikkel

307 (31) matt kroom

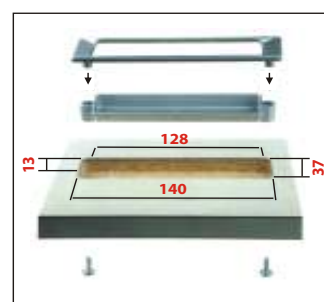
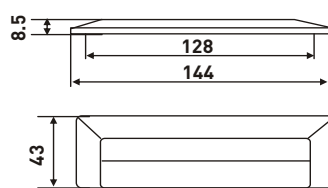
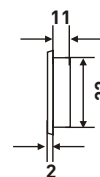
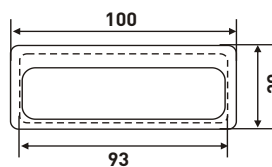
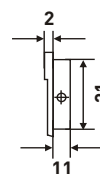
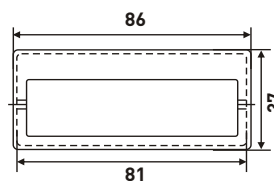
tsentrite vahe 128 mm

tsentrite vahe 128 mm

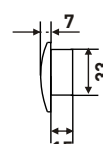
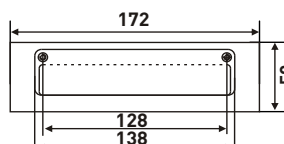

Art. 151.01.729 lihvitud nikkel

Art. 151.09.600 matt nikkel/sisu must

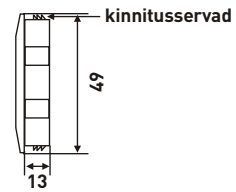
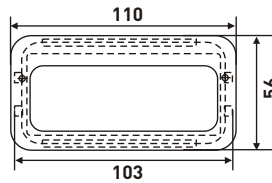
Art. 151.22.400 matt kroom

tsentrite vahe 128 mm

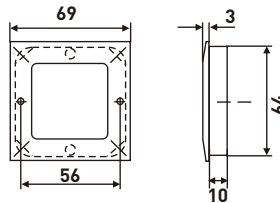

SISSEFREESITAVAD KÄEPIDEMED - kroom / plastik / alumiiniumviimistlus
Art. 151.35.262 matt kroom

Art. 151.67.901 alumiiniumviimistlus

tsentrite vahe 56 mm

Art. 151.68.903 alumiiniumviimistlus

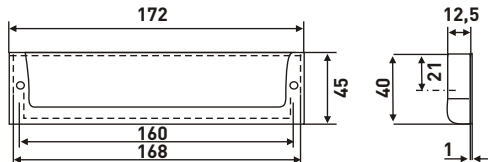
tsentrite vahe 160 mm

Art. 151.76.901 alumiiniumviimistlus

tsentrite vahe 96 mm

151.76.902 alumiiniumviimistlus

tsentrite vahe 128 mm

151.76.903 alumiiniumviimistlus

tsentrite vahe 160 mm

151.76.904 alumiiniumviimistlus

tsentrite vahe 192 mm

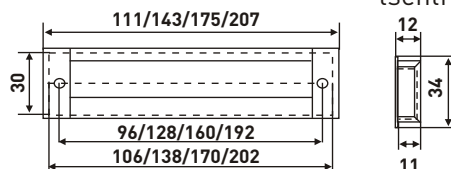
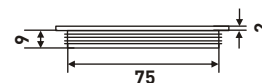
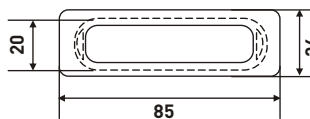
Art. 158.42.921 plastik/matt kroom/sisu must

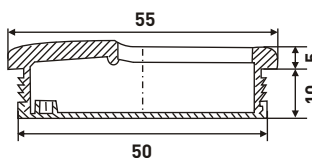
Art. A-618.T1 plastik/valge

A-618.T10 plastik/must

REELINGKÄEPIDEMED - nikkel / alumiinium

- Art. 885-156 ZN4** matt nikkel
885-156 ZN21 lihvitud nikkel
885-188 ZN4 matt nikkel
885-188 ZN21 lihvitud nikkel
885-254 ZN4 matt nikkel
885-254 ZN21 lihvitud nikkel
885-370 ZN4 matt nikkel
885-370 ZN21 lihvitud nikkel
885-460 ZN4 matt nikkel
885-460 ZN21 lihvitud nikkel
885-537 ZN4 matt nikkel
885-537 ZN21 lihvitud nikkel
885-635 ZN4 matt nikkel
885-635 ZN21 lihvitud nikkel
885-796 ZN4 matt nikkel
885-796 ZN21 lihvitud nikkel
885-1449 ZN4 matt nikkel
885-1449 ZN21 lihvitud nikkel



- tsentrite vahe 96 mm
 tsentrite vahe 96 mm
 tsentrite vahe 128 mm
 tsentrite vahe 128 mm
 tsentrite vahe 176 mm
 tsentrite vahe 176 mm
 tsentrite vahe 320 mm
 tsentrite vahe 320 mm
 tsentrite vahe 400 mm
 tsentrite vahe 400 mm
 tsentrite vahe 477 mm
 tsentrite vahe 477 mm
 tsentrite vahe 552 mm
 tsentrite vahe 552 mm
 tsentrite vahe 736 mm
 tsentrite vahe 736 mm
 tsentrite vahe 1368 mm
 tsentrite vahe 1368 mm

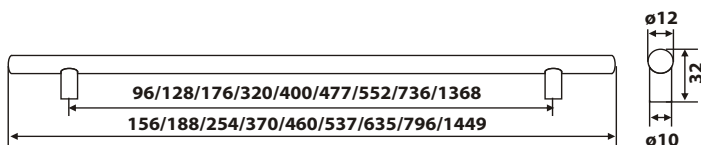

- Art. 1206-228 AL1** alumiinium
1206-388 AL1 alumiinium
1206-420 AL1 alumiinium
1206-580 AL1 alumiinium
1206-996 AL1 alumiinium



- tsentrite vahe 128 mm
 tsentrite vahe 288 mm
 tsentrite vahe 320 mm
 tsentrite vahe 480 mm
 tsentrite vahe 896 mm

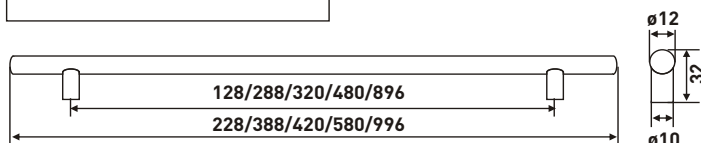

KÄEPIDEMED / NUPUD - alumiinium

- Art. 110.56.921 alumiinium
 110.56.940 alumiinium
 110.56.922 alumiinium
 110.56.924 alumiinium
 110.56.942 alumiinium
 110.56.943 alumiinium

tsentrite vahe 32 mm
 tsentrite vahe 96 mm
 tsentrite vahe 128 mm
 tsentrite vahe 192 mm
 tsentrite vahe 320 mm
 tsentrite vahe 448 mm

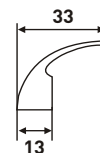
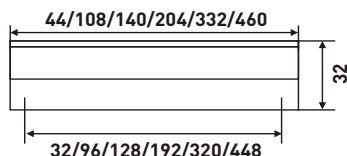

- Art. 110.71.901 alumiinium
 110.71.902 alumiinium
 110.71.903 alumiinium
 110.71.904 alumiinium
 110.71.911 alumiinium

tsentrite vahe 32 mm
 tsentrite vahe 64 mm
 tsentrite vahe 96 mm
 tsentrite vahe 128 mm
 tsentrite vahe 320 mm

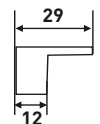
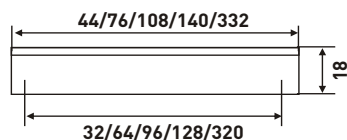

- Art. SAS 1276-206 AL1MV2 alumiinium/plastmass
 SAS 1276-238 AL1MV2 alumiinium/plastmass

tsentrite vahe 192 mm
 tsentrite vahe 224 mm

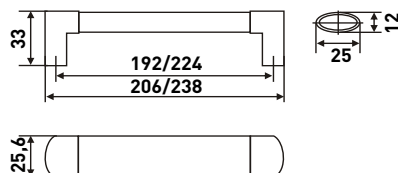

- Art. 1488-140 alumiinium/plastmass
 1488-172 alumiinium/plastmass
 1488-204 alumiinium/plastmass
 1488-300 alumiinium/plastmass
 1488-364 alumiinium/plastmass
 1488-460 alumiinium/plastmass

tsentrite vahe 128 mm
 tsentrite vahe 160 mm
 tsentrite vahe 192 mm
 tsentrite vahe 288 mm
 tsentrite vahe 352 mm
 tsentrite vahe 448 mm

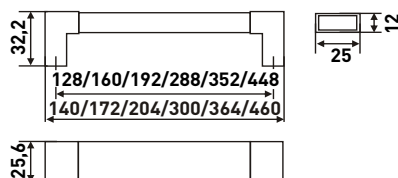

- Art. 1624-16 AL1 **Tühistatud**

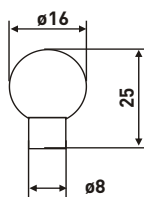

KÄEPIDEMED - alumiinium

Art. 124.02.220 kroom
124.02.920 alumiinium

tsentrite vahe 50 mm
tsentrite vahe 50 mm

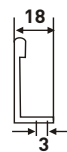
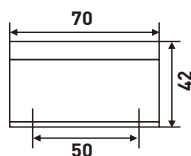

Art. 126.20.905 alumiinium

L = 2500 mm

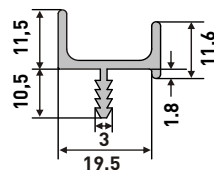

Art. 126.22.909 alumiinium

L = 2500 mm

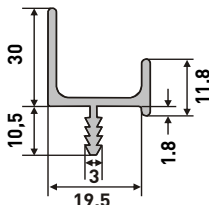

Art. 126.35.925 alumiinium

L = 2500 mm

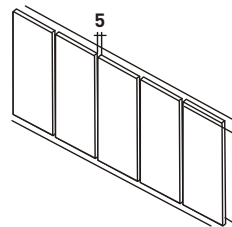
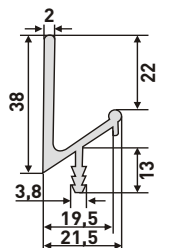

Art. 126.34.925 alumiinium

L = 2500 mm

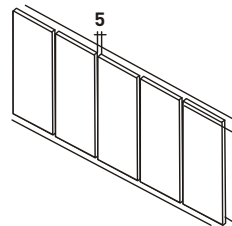
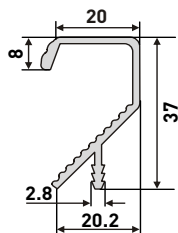
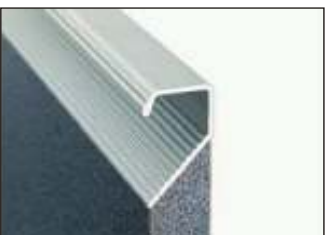

KÄEPIDEMED - antiikpronks / pronks
Art. 563-105 ZN10 pronks

tsentrite vahe 96 mm

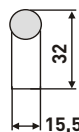
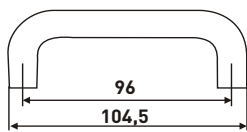

Art. 1469-120 ZN38 pronks

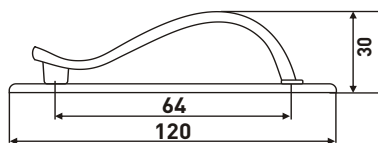
tsentrite vahe 64 mm

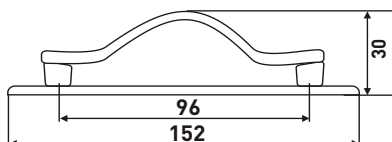
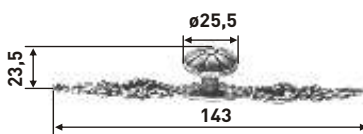

Art. 1470-152 ZN38 pronks

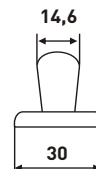
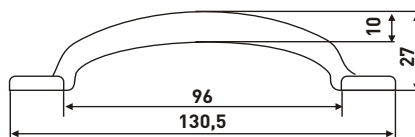
tsentrite vahe 96 mm

Art. 1474-143 ZN10 antiikpronks

Art. 1534-130 ZN10 pronks
1534-130 ZN29 antiikhõbe

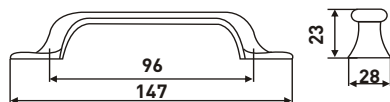
 tsentrite vahe 96 mm
 tsentrite vahe 96 mm

Art. 1198-147 ZN8 antiiktsink

tsentrite vahe 96 mm

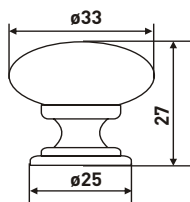

KÄEPIDEMED / NUPUD - antiikhõbe / pronks / messing

Art. 1533-33 ZN10 pronks
1533-33 ZN29 antiikhõbe



Art. 811-93 ZN10 pronks

tsentrite vahe 64 mm

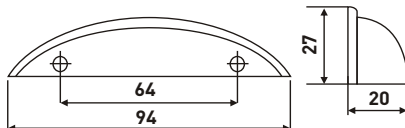

Art. 854-97 MS21 **Tühistatud**
854-120 MS22 **Tühistatud**

tsentrite vahe 78 mm
tsentrite vahe 96 mm

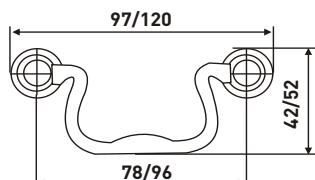

Art. 852-28 MS21 **Tühistatud**
852-28 MS22 **Tühistatud**
852-38 MS22 **Tühistatud**

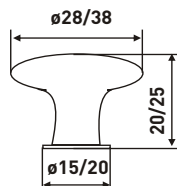

Art. 855-32 MS21 **Tühistatud**
855-32 MS22 **Tühistatud**

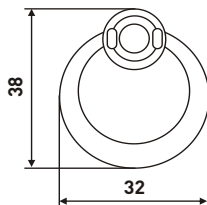

Art. 859-110 MS21 **Tühistatud**
859-110 MS22 **Tühistatud**

tsentrite vahe 96 mm

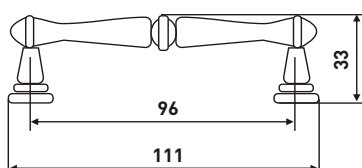

KÄEPIDEMED / NUPUD - portselan / kombinatsioonid
Art. 1017 (20) pronks/portselan

tsentrite vahe 96 mm

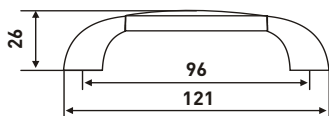
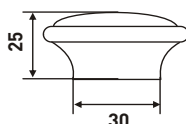
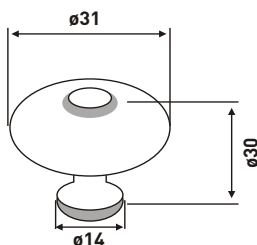

Art. 2028 (20) pronks/portselan

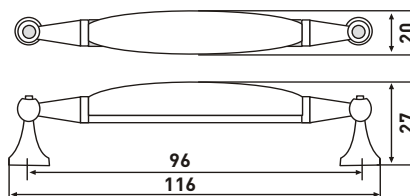
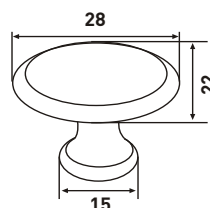
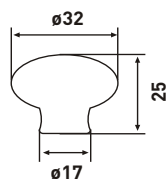
Art. SP5-35 SPMS3 antiikmehing/portselan

Art. 1699 - 107 PC5ZN48 pronks/mõranenud portselan

tsentrite vahe 96 mm

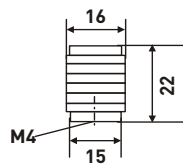

Art. 1700 - 29 PC5ZN48 pronks/mõranenud portselan

Art. 130.08.707 portselan

KÄEPIDEMED / NUPUD - nahk / kombinatsioonid

Art. 103.87.140 tumepruun/matt kroom

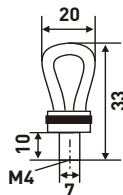

Art. 105.96.190 helepruun/matt kroom



Art. 110.78.413 helepruun/matt kroom

tsentrite vahe 160 mm

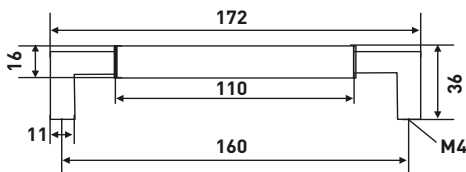

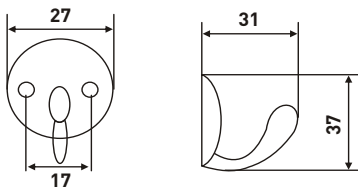
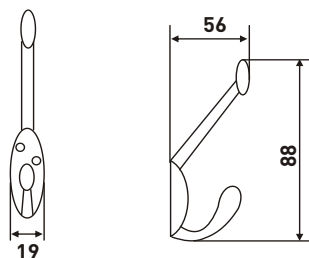
NAGID- kroom / kuld / pronks
Art.743 ZN1 kroom

Art. 745 ZN1 kroom

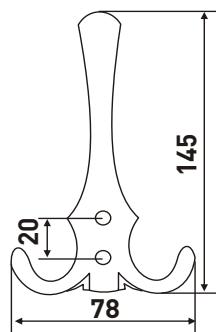
Art. Z-375 ZN1 kroom

Z-375 ZN2 matt kroom

Z-375 ZN4 **Tühistatud**
Z-375 ZN10 pronks

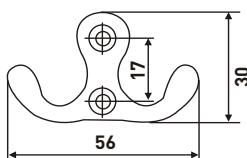
Art. Z-391-110 ZN1 kroom

Z-391-110 ZN2 matt kroom

Z-391-110 ZN5 kuld

Z-391-110 ZN10 pronks

NAGID- kroom / nikkel / pronks / puit

Art. 1104 ZN1 kroom / kruviga
1108 ZN2 matt kroom / kruviga
1105 ZN10 pronks / kruviga

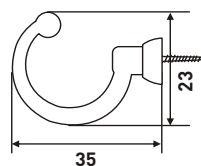

Art. 135906 Tühistatud

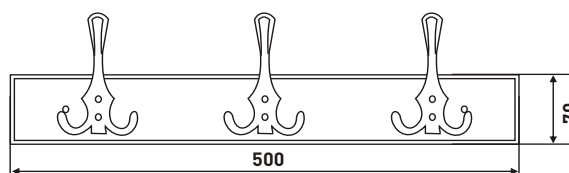

Art. 138906 Tühistatud

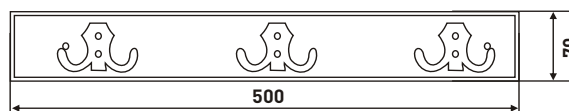

Art. 481104 Tühistatud

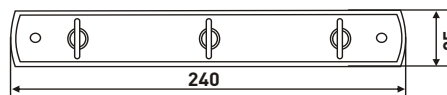

ART. NR	LK	KIRJELDUS
001.35.001	2	puurimisrakis
17.23.200	7	käepide - kroom
17.23.201	7	käepide - matt nikkel
17.23.210	7	käepide - kroom
17.23.211	7	käepide - matt nikkel
17.23.212	7	käepide - kuld
17.23.213	7	käepide - matt kroom
17.23.216	7	käepide - kroom
17.23.218	7	käepide - matt nikkel
17.23.219	7	käepide - matt kroom
17.23.297	7	käepide - matt nikkel
17.23.400	7	käepide - matt nikkel
17.23.933	8	käepide - matt nikkel
17.23.937	8	käepide - matt nikkel
17.23.942	8	käepide - lihvitud nikkel
22.03.015	13	klaasukse käepide - kroom
101.12.904	8	käepide - alumiiniumviimistlus
102.04.600	8	käepide - matt nikkel
102.27.210	8	käepide - kroom
102.27.220	8	käepide - kroom
102.27.310	8	käepide - matt must
102.27.320	8	käepide - matt must
102.27.410	8	käepide - matt kroom
102.27.420	8	käepide - matt kroom
103.33.402	8	käepide - lihvitud nikkel
103.87.140	22	nupp - tumepruun/matt kroom
105.96.190	22	nupp - helepruun/matt kroom
109.50.904	9	käepide - alumiiniumviimistlus
110.41.400	9	käepide - matt kroom
110.41.401	9	käepide - matt kroom
110.41.403	9	käepide - matt kroom
110.41.405	9	käepide - matt kroom
110.56.921	17	käepide - alumiinium
110.56.940	17	käepide - alumiinium
110.56.922	17	käepide - alumiinium
110.56.924	17	käepide - alumiinium
110.56.942	17	käepide - alumiinium
110.56.943	17	käepide - alumiinium
110.71.901	17	käepide - alumiinium
110.71.902	17	käepide - alumiinium
110.71.903	17	käepide - alumiinium
110.71.904	17	käepide - alumiinium
110.71.911	17	käepide - alumiinium
110.75.903	9	käepide - alumiiniumviimistlus
110.75.906	9	käepide - alumiiniumviimistlus
110.75.907	9	käepide - alumiiniumviimistlus
110.75.908	9	käepide - alumiiniumviimistlus
110.78.413	22	käepide - helepruun/matt kroom
117.31.226	9	käepide - kroom
117.31.326	9	käepide - must
117.31.426	9	käepide - matt kroom
117.31.826	9	käepide - kuld
124.02.220	18	käepide - kroom
124.02.920	18	käepide - alumiinium
126.20.905	18	käepide - alumiinium
126.22.909	18	käepide - alumiinium
126.35.925	18	käepide - alumiinium
126.34.925	18	käepide - alumiinium
130.08.707	21	nupp - portselan
135.93.903	12	nupp - alumiiniumviimistlus
135.95.003	12	nupp - lihvitud nikkel
151.01.729	14	käepide - lihvitud nikkel
151.09.600	14	käepide - matt nikkel/sisu must
151.22.400	14	käepide - matt kroom
151.35.262	15	käepide - matt kroom
151.67.901	15	käepide - alumiiniumviimistlus
151.68.903	15	käepide - alumiiniumviimistlus
151.76.901	15	käepide - alumiiniumviimistlus
151.76.902	15	käepide - alumiiniumviimistlus
151.76.903	15	käepide - alumiiniumviimistlus

ART. NR	LK	KIRJELDUS
151.76.904	15	käepide - alumiiniumviimistlus
154.22.717	13	klaasukse käepide - nikkel
154.22.313	13	klaasukse käepide - matt must
154.25.210	13	klaasukse käepide - kroom
158.42.921	15	käepide - plastik/sisu must
0203	14	käepide - kuld
0207	14	käepide - lihvitud nikkel
0208	14	käepide - matt kroom
0408/160 ZN2	6	käepide - matt kroom
254 (31)	3	käepide - matt kroom
254 (52)	3	käepide - matt must
261 (11)	14	käepide - lihvitud nikkel
261 (31)	14	käepide - matt kroom
265 (31)	3	käepide - matt kroom
301 A (11)	3	käepide - lihvitud nikkel
301 B (11)	3	käepide - lihvitud nikkel
303 A (11)	3	käepide - lihvitud nikkel
303 A (31)	3	käepide - matt kroom
305 (11)	3	käepide - lihvitud nikkel
305 (31)	3	käepide - matt kroom
305 (33)	3	käepide - matt nikkel-lakitud
307 (11)	14	käepide - lihvitud nikkel
307 (31)	14	käepide - matt kroom
311 (31)	3	käepide - matt kroom
311 (33)	3	käepide - matt nikkel-lakitud
311 (52)	3	käepide - matt must
312 (10)	10	nupp - kroom
312 (11)	10	nupp - lihvitud nikkel
312 (31)	10	nupp - matt kroom
312 (52)	10	nupp - matt must
313 A (31)	4	käepide - matt kroom
313 B (31)	4	käepide - matt kroom
313 C (31)	4	käepide - matt kroom
313 D (31)	4	käepide - matt kroom
314 (11)	11	nupp - lihvitud nikkel
314 (31)	11	nupp - matt kroom
322 A (11)	4	käepide - lihvitud nikkel
322 A (31)	4	käepide - matt kroom
322 C (11)	4	käepide - lihvitud nikkel
322 C (31)	4	käepide - matt kroom
323 (11)	4	käepide - lihvitud nikkel
323 (31)	4	käepide - matt kroom
335 (31)	4	käepide - matt kroom
563-105 ZN10	19	käepide - pronks
646-18 MS1	11	nupp - kuld
646-18 MS4	11	nupp - kroom
646-18 MS9	11	nupp - lihvitud nikkel
743 ZN1	23	nagi - kroom
745 ZN1	23	nagi - kroom
810-153 ZN4	4	käepide - matt nikkel
811-93 ZN10	24	käepide - pronks
820-85 mm ZN4	5	käepide - matt nikkel
852-28 MS21	20	nupp - messing/antiikhõbe
852-28 MS22	20	nupp - messing/antiikpronks
852-38 MS22	20	nupp - messing/antiikpronks
854-97 MS21	20	käepide - messing/antiikhõbe
854-120 MS22	20	käepide - messing/antiikpronks
855-32 MS21	20	käepide - messing/antiikhõbe
855-32 MS22	20	käepide - messing/antiikpronks
859-110 MS21	20	käepide - messing/antiikhõbe
859-110 MS22	20	käepide - messing/antiikpronks
873-28 ZN2	10	nupp - matt kroom
873-28 ZN4	10	nupp - matt nikkel
873-28 ZN10	10	nupp - pronks
876-81 ZN4	4	käepide - matt nikkel
876-119 ZN4	4	käepide - matt nikkel
878-128 ZN2	10	käepide - matt kroom
878-128 ZN4	10	käepide - matt nikkel
878-128 ZN10	10	käepide - pronks
878-160 ZN2	10	käepide - matt kroom

